



Operating Instructions perma ULTRA



11/05/2023 - A01 - Art. No. 115207



perma-tec GmbH & Co. KG
Hammelburger Str. 21
97717 Euerdorf
GERMANY

Tel.: +49 9704 609 - 0
info@perma-tec.com
www.perma-tec.com

The Expert in Lubrication Solutions

perma



				
1.0	Eigenschaften	Properties	Características	1 - 4
2.0	Teile / Erstmontage	Components / Initial assembly	Piezas / Primer montaje	5 - 6
3.0	Bedienung	Handling	Manejo	
	3.1 Anzeigen	3.1 Displays	3.1 Indicadores	7 - 8
	3.2 Konfiguration	3.2 Configuration	3.2 Configuración	9 - 10
	3.3 Betriebszustände	3.3 Operating states	3.3 Estados de servicio	11 - 14
4.0	Installation	Installation	Instalación	
	4.1 Anbau	4.1 Mounting	4.1 Montaje	15 - 16
	4.2 Inbetriebnahme	4.2 Setting into operation	4.2 Puesta en marcha	17 - 18
5.0	LC-Wechsel	LC exchange	Cambio LC	19 - 20
6.0	Fehlerbehebung	Troubleshooting	Solución de problemas	21 - 22
7.0	Entsorgung	Waste disposal	Eliminación de residuos	23
8.0	Kennzeichnung	Markings	Distintivo	24 - 25

	Originalbetriebsanleitung	de	27 - 28
	Translation of the Original Operating Instructions	en	29 - 30
	Traducción del manual de instrucciones original	es	31 - 32
	Traduction de la notice originale	fr	33 - 36
	Traduzione del manuale d'uso originale	it	37 - 40
	Tradução do Manual de instruções original	pt	41 - 44
	Перевод оригинала руководства по эксплуатации	ru	45 - 48
	Bohrschablone Drilling template Plantilla para agujeros		50 - 51

1.0 Eigenschaften Properties Características



A Deckel (wiederverwendbar)
Cover (re-usable)
Tapa (reutilizable)

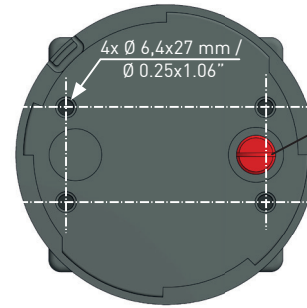

4x Ø 6,4x27 mm /
Ø 0.25x1.06"
R1/4i
R 1/4 female
R1/4 hembra

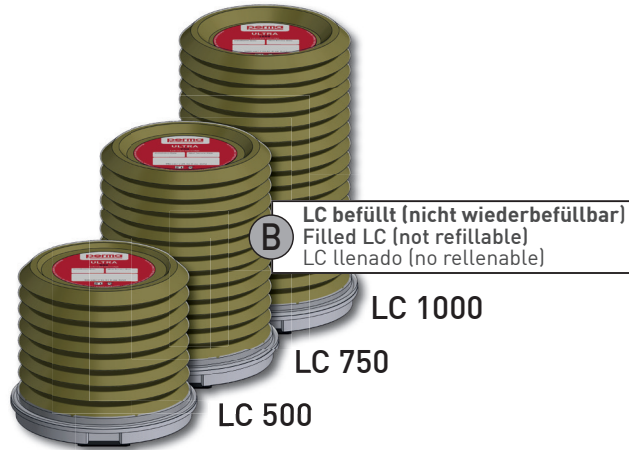

B LC befüllt (nicht wiederbefüllbar)
Filled LC (not refillable)
LC llenado (no rellenable)

LC 1000
LC 750
LC 500



C Batterieset (nicht wiederverwendbar)
Battery pack (not re-usable)
Juego de pilas (no reutilizable)

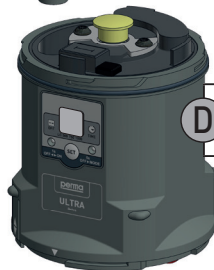

D Antrieb (wiederverwendbar)
Drive (re-usable)
Motor (reutilizable)

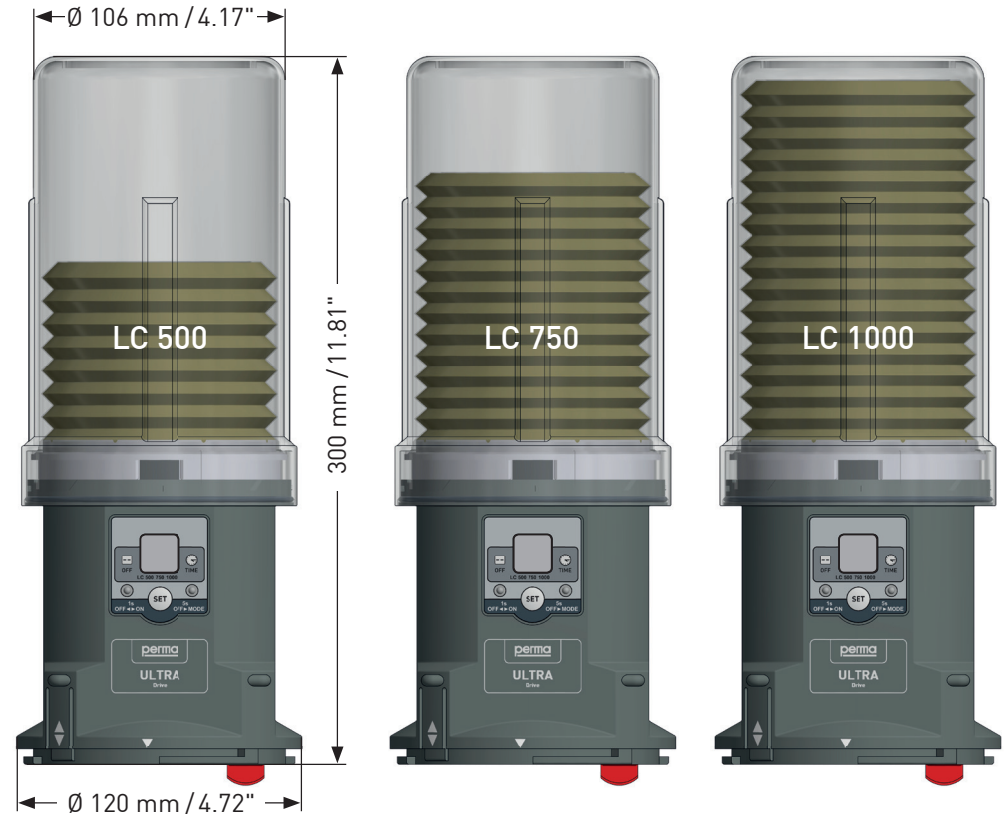



E Lagerungsbedingungen
Storage conditions
Condiciones de almacenamiento

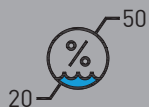

+ 20 °C
+ 68 °F



A **D** max. 2 J (y)
B **C** max. 1 J (y)

B  

LC 500	500 cm ³ / 16.91 fl. oz. (US)
LC 750	750 cm ³ / 25.36 fl. oz. (US)
LC 1000	1000 cm ³ / 33.81 fl. oz. (US)

A + **B** + **C** + **D** 

500	≈ 1540 g / 54.3 oz. (US)
750	≈ 1780 g / 62.8 oz. (US)
1000	≈ 2015 g / 71.1 oz. (US)



(500) UE – JJWW (yyww) – #####
(750) UF – JJWW (yyww) – #####
(1000) UG – JJWW (yyww) – #####

F Einsatztemperatur
Operating temperature
Temperatura de aplicación

-20 °C / -4 °F to +60 °C / +140 °F

-40 °C / -40 °F to +60 °C / +140 °F

C Batterieset (nicht wiederverwendbar)
Battery pack (not re-usable)
Juego de pilas (no reutilizable)



6 V / 3.0 Ah

G1 Alkali-Mangan
Alkaline manganese
Alcalina de manganeso



6 V / 3.0 Ah

G2 Lithium
Lithium
Litio



H Spendezeit
Discharge period
Tiempo de dosificación

1 - 12 Monate
1 - 12 months
1 - 12 meses

1 - 26 Wochen
1 - 26 weeks
1 - 26 semanas



7 - 10

I Einbaulage
Shaft orientation
Posición de instalación

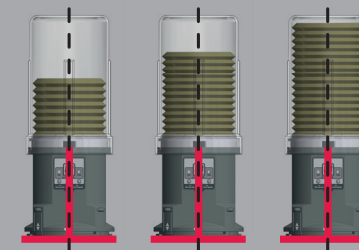

15 - 16



50 bar / 725 psi

J Luftschallemission
Airborne noise emission
Emisión de ruido aéreo



< 70 dB(A)



IP 67 / IP 65



perma CONNECT
Android 7.0 / iOS 12



BLE

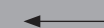

10



24 - 25

2.0 Teile / Erstmontage Components / Initial assembly Piezas / Primer montaje

C Batterieset (nicht wiederverwendbar)
Battery pack (not re-usable)
Juego de pilas (no reutilizable)

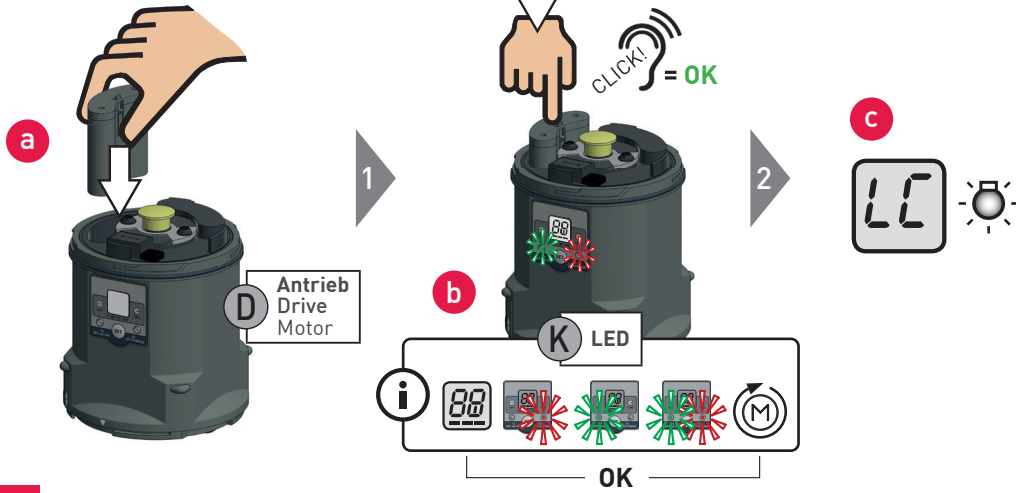

1	Erstmontage	Initial assembly	Montaje inicial
a	Batterieset in den Antrieb einschieben und einrasten.	Insert the battery pack into the drive and click it into place.	Insertar el juego de pilas en motor y hacer encajar.
b	Automatischer Selbsttest	Automatic self-test	Autoevaluación automática
c	Im Display erscheint „LC“. Nach 60 s erlischt die Hintergrundbeleuchtung.	Display shows "LC". After 60 s, background lighting disappears.	El display muestra "LC". La luz de fondo se apaga a los 60 s.
d	Verschlussstopfen vom Antrieb entfernen und entsorgen.	Remove plug from drive and dispose of it.	Retirar el tapón cierre del motor y eliminarlo.
e	LC nur am Boden festhalten. Transportsicherung und Verschlussstopfen entfernen und entsorgen. Leicht auf LC drücken, bis Schmierstoff am Auslass ansteht.	Hold LC on bottom only. Remove transport protection and plug and dispose of it. Slightly squeeze the LC until lubricant reaches the outlet.	Coger la unidad LC solo por la parte inferior. Retirar el cierre de transporte y el tapón cierre y eliminarlos. Presionar ligeramente la unidad LC hasta que el lubricante llegue a la salida.
f	LC mittig auf Antrieb aufsetzen und dabei zur vorderen Lasche ausrichten und einrasten. Die LC-Größe wird automatisch erkannt.	Place LC on center of drive and adjust it with front lug until it catches. System automatically recognizes LC size.	Colocar la unidad LC centrada en el motor en dirección a la pestaña delantera y encajarla. El sistema reconocerá el tamaño de la unidad LC de forma automática.
g	Deckel über LC setzen und bis zum Einrasten drehen.	Place cover over LC and turn until it catches.	Colocar la tapa encima de la unidad LC y girarla hasta que encaje.

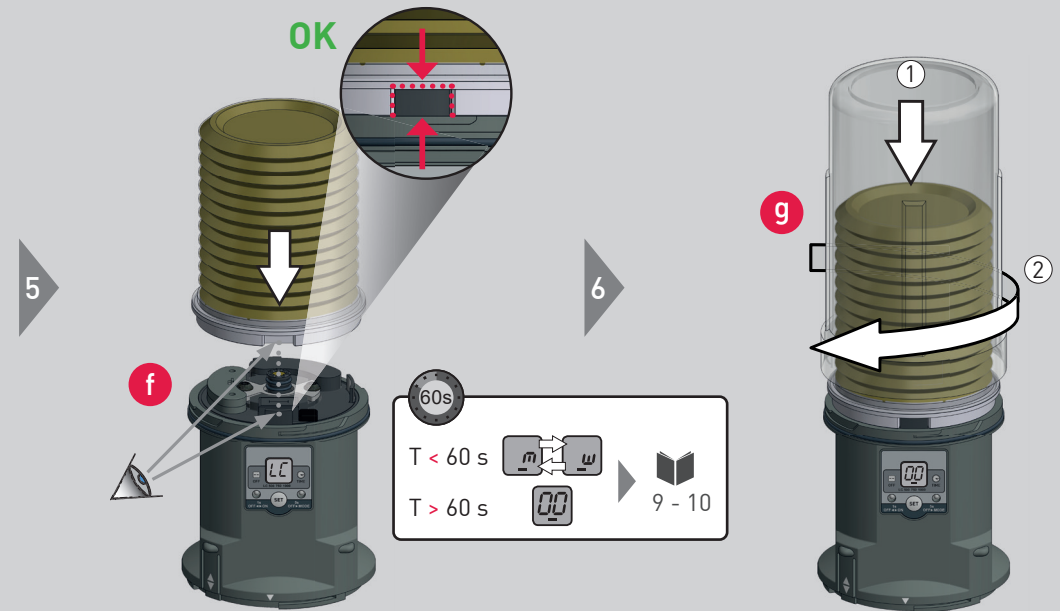
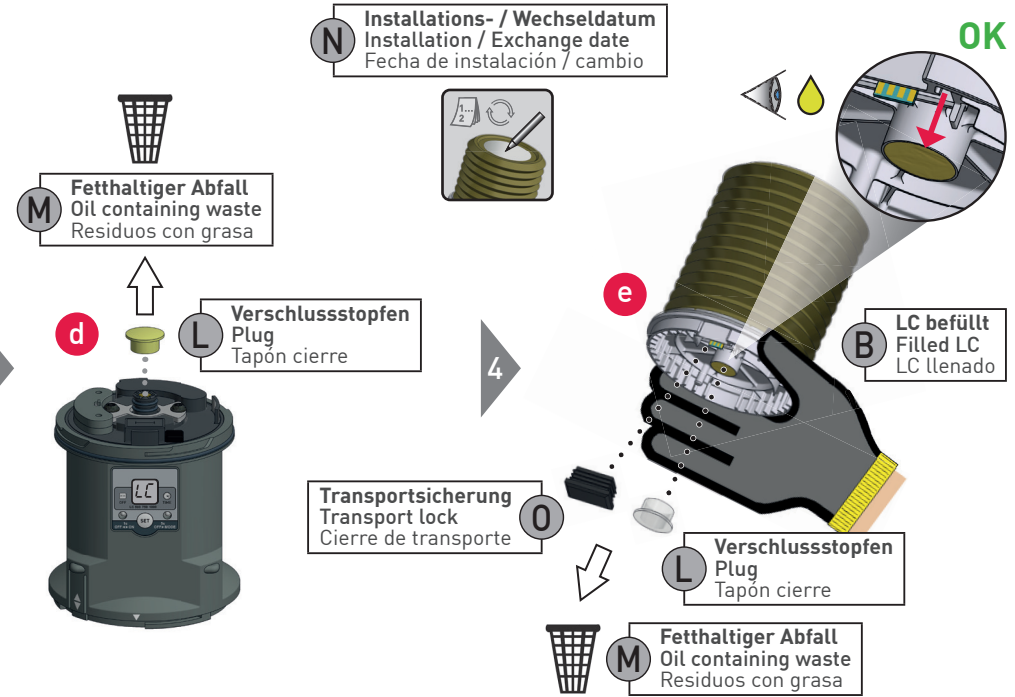

3.0 Bedienung Handling Manejo

3.1 Anzeigen Displays Indicadores



2

Die Schmierstoffabgabe erfolgt zeitgesteuert.
Lubricant discharge is time controlled.
La dosificación del lubricante es por tiempo.

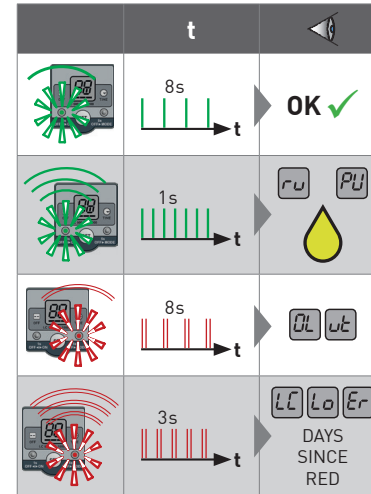
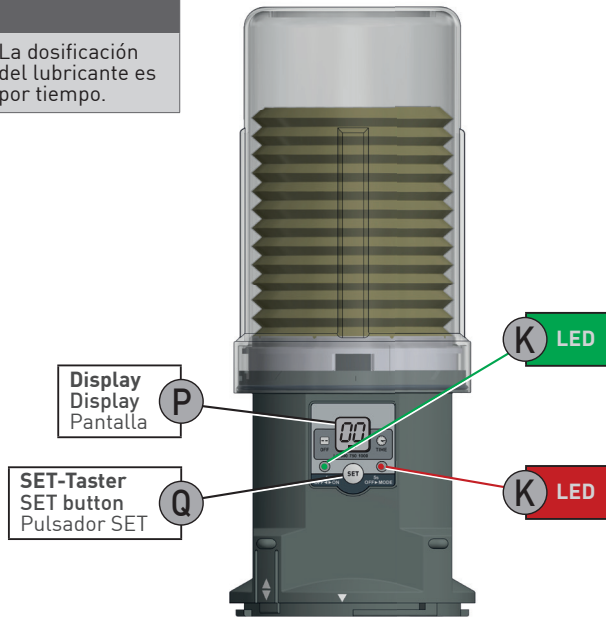
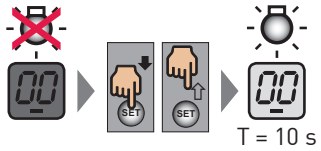

B LC befüllt (nicht wiederbefüllbar)
Filled LC (not refillable)
LC llenado (no rellenable)

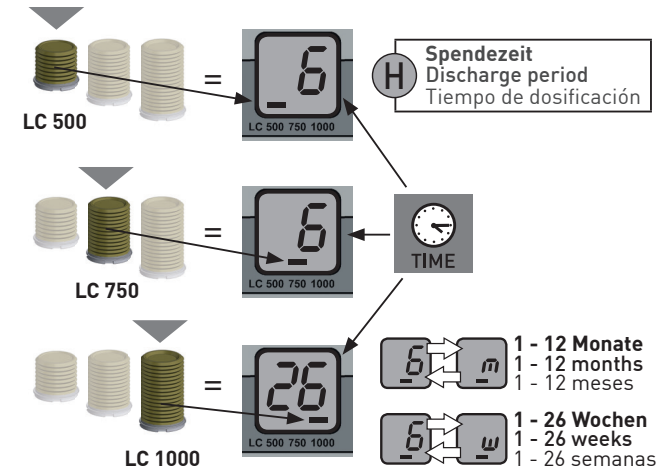

Spendemenge Discharge amount Cantidad de dosificación 0,5 cm ³ /	LC 500	[cm ³ /24 h]
	LC 750	[cm ³ /24 h]
	LC 1000	[cm ³ /24 h]
Spendezeit Discharge period Tiempo de dosificación	1 - 12 Monate	1 - 12 months
	1 - 26 Wochen	1 - 26 weeks

16,4	8,2	5,5	4,1	3,3	2,7	2,4	2,1	1,8	1,7	1,5	1,4
68,5	34,3	22,8	17,1	13,7	11,4	9,8	8,6	7,6	6,9	6,2	5,7
24,7	12,3	8,2	6,2	4,9	4,1	3,5	3,1	2,7	2,5	2,2	2,1
102,8	51,4	34,3	25,7	20,6	17,1	14,7	12,8	11,4	10,3	9,3	8,6
32,9	16,4	11,0	8,2	6,6	5,5	4,7	4,1	3,6	3,3	3,0	2,7
137,1	68,5	45,7	34,3	27,4	22,8	19,6	17,1	15,2	13,7	12,5	11,4
1	2	3	4	5	6	7	8	9	10	11	12
m	m	m	m	m	m	m	m	m	m	m	m

1 - 12 Monate / months / meses

71,4	35,7	23,8	17,9	14,3	11,9	10,2	8,9	7,9	7,2	6,5	6,0	5,5	5,1	4,8	4,5	4,2	4,0	3,8	3,6	3,4	3,2	3,1	3,0	2,9	2,7
297,6	148,8	99,2	74,4	59,5	49,6	42,5	37,2	33,1	29,8	27,1	24,8	22,9	21,3	19,8	18,6	17,5	16,5	15,7	14,9	14,2	13,5	12,9	12,4	11,9	11,4
107,1	53,6	35,7	26,8	21,4	17,9	15,3	13,4	11,9	10,7	9,7	8,9	8,2	7,7	7,2	6,7	6,3	6,0	5,6	5,4	5,1	4,9	4,7	4,5	4,3	4,1
446,4	223,2	148,8	111,6	89,3	74,4	63,8	55,8	49,6	44,6	40,6	37,2	34,3	31,9	29,8	27,9	26,3	24,8	23,5	22,3	21,3	20,3	19,4	18,6	17,9	17,2
142,8	71,4	47,6	35,7	28,6	23,8	20,4	17,9	15,9	14,3	13,0	11,9	11,0	10,2	9,5	8,9	8,4	7,9	7,5	7,2	6,8	6,5	6,2	6,0	5,7	5,5
595,2	297,6	198,4	148,8	119,0	99,2	85,0	74,4	66,1	59,5	54,1	49,6	45,8	42,5	39,7	37,2	35,0	33,1	31,3	29,8	28,3	27,1	25,9	24,8	23,8	22,9
1	2	3	4	5	6	7	8	9	10	11	12	13	14	15	16	17	18	19	20	21	22	23	24	25	26
w	w	w	w	w	w	w	w	w	w	w	w	w	w	w	w	w	w	w	w	w	w	w	w	w	w

1 - 26 Wochen / weeks / semanas

3.2 Konfiguration Configuration Configuración

3	Zeiteinheit einstellen	Setting time unit	Ajustar el tiempo
a	SET-Taster bei Ersteinstellung ① für 1 s und bei Änderung der Einstellung ② für 5 s gedrückt halten.	Hold down SET button for 1 s during initial setup ① and for 5 s when changing the setting ②.	Mantener pulsada el pulsador SET para el primer ajuste ① por 1 s y para modificaciones ②, 5 s.
b	Die Wechselanzeige m / w erscheint.	The exchange indicator m / w appears.	Aparecerá m / w en cambio.
c	Durch Drücken des SET-Tasters die Zeiteinheit (m, w) einstellen: 1x = m (Monate) 2x = w (Wochen)	Set unit of time (m, w) by pressing the SET button: 1x = m (months) 2x = w (weeks)	Para ajustar el tiempo (m, w): 1x = m (meses) 2x = w (semanas), pulsar el pulsador SET.
d	Nach 3 s wird die Änderung (ohne Drücken des SET-Tasters) übernommen.	The change is applied after 3 s (without pressing the SET button).	Después de 3 s se acepta el cambio (sin pulsar el pulsador SET).

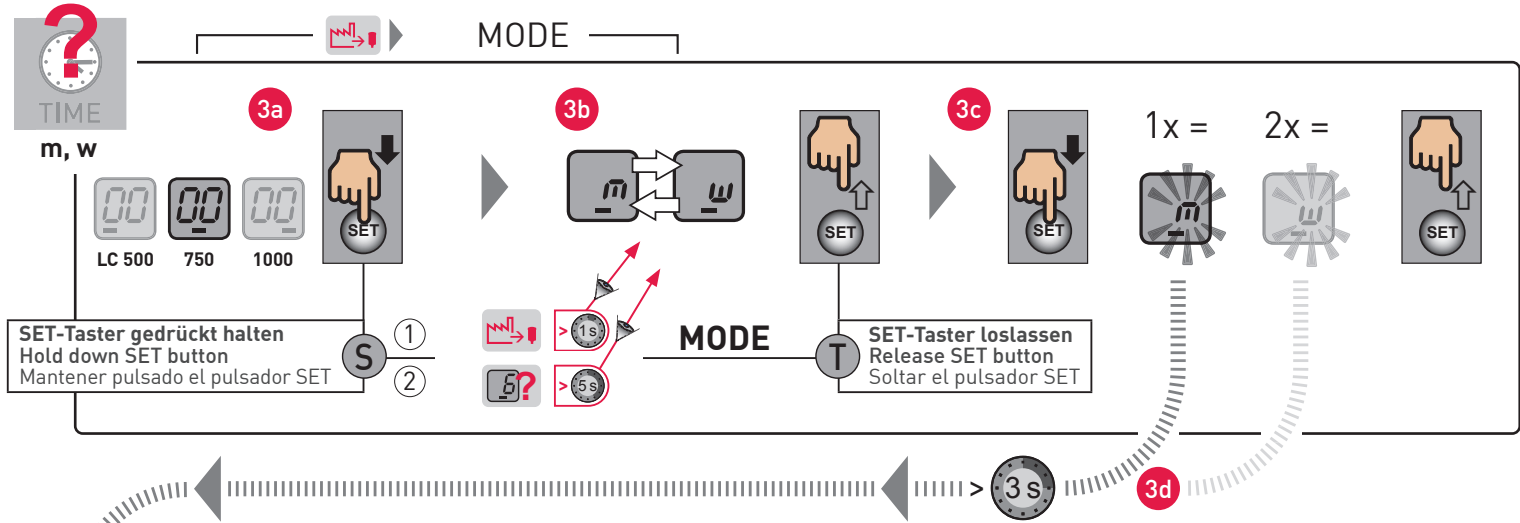



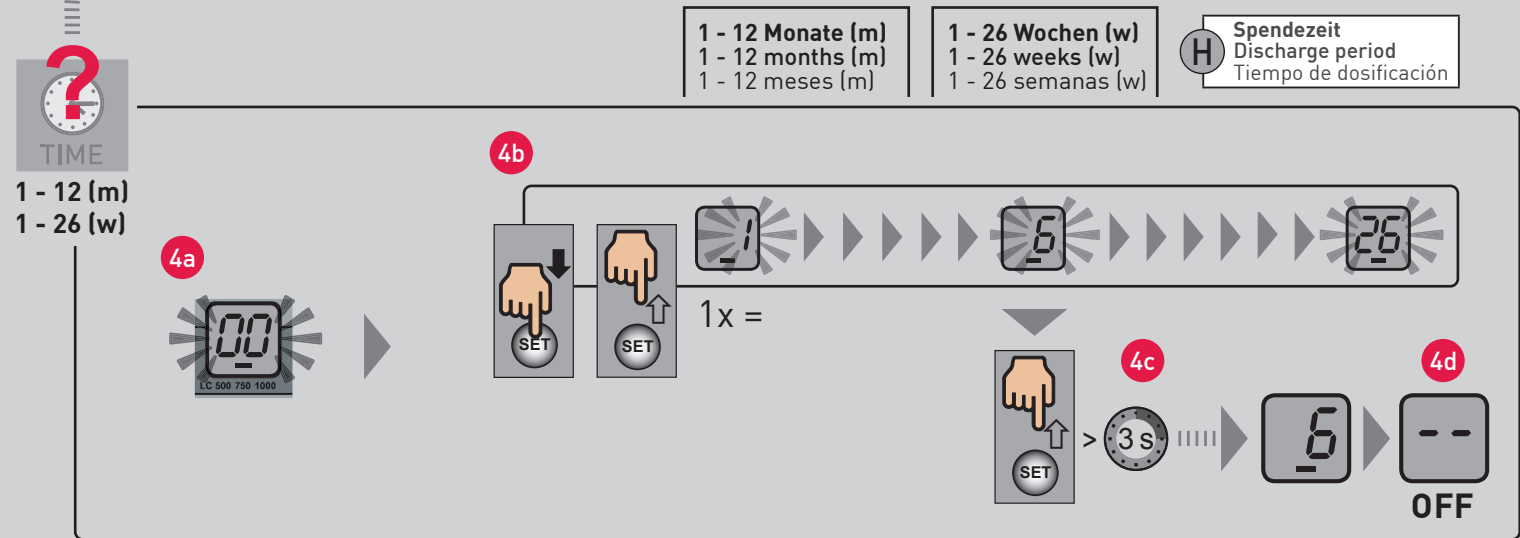





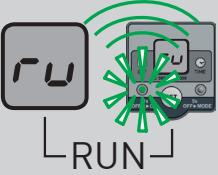





4	Dauer der Spendezeit einstellen	Setting discharge period	Ajustar el tiempo de dosificación deseado
a	Einstellung möglich, sobald die Ziffern blinken.	Once the numbers are flashing you can set it.	Posibilidad de ajuste en cuanto las cifras parpadean.
b	Die Dauer der Spendezeit entweder durch Einzel- oder durch Dauertastendruck (= Scrollen) einstellen.	Set the discharge period either with a single button stroke or a continuous button stroke (= scrolling).	Ajustar la duración del tiempo de dosificación mediante presión corta de la tecla o larga (= función desplazar).
c	Nach 3 s wird die Änderung (ohne Drücken des SET-Tasters) übernommen.	The change is applied after 3 s (without pressing the SET button).	Después de 3 s se acepta el cambio (sin pulsar el pulsador SET).
d	Nach erfolgter Übernahme der Einstellungen schaltet sich das System ab.	The system switches itself off once the settings have been applied successfully.	Tras aceptar los ajustes, el sistema se apaga.

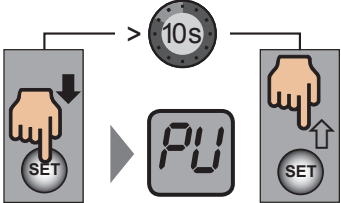

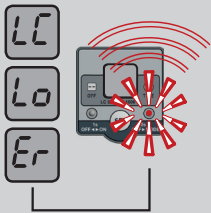
3.3 Betriebszustände
Operating states
Estados de servicio

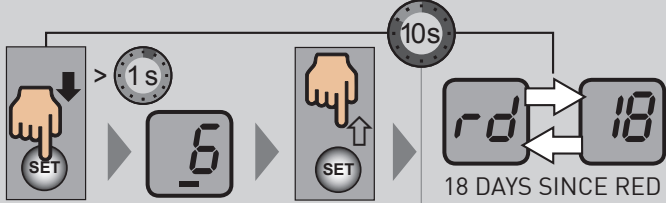
	5 – 7				OK	OK			
 OFF	<div style="background-color: #f00; color: white; padding: 2px; display: inline-block; font-weight: bold;">5</div> <table border="1" style="width: 100%; border-collapse: collapse;"> <tr> <td style="width: 33%; padding: 5px;"> Zum Einschalten SET-Taster für 1 s gedrückt halten. </td> <td style="width: 33%; padding: 5px;"> Hold down the SET button for 1 s to switch on. </td> <td style="width: 33%; padding: 5px;"> Mantener pulsado el pulsador SET durante 1 s para encender. </td> </tr> </table>	Zum Einschalten SET-Taster für 1 s gedrückt halten.	Hold down the SET button for 1 s to switch on.	Mantener pulsado el pulsador SET durante 1 s para encender.	OFF ► ON	 17			 ON
Zum Einschalten SET-Taster für 1 s gedrückt halten.	Hold down the SET button for 1 s to switch on.	Mantener pulsado el pulsador SET durante 1 s para encender.							
	<div style="background-color: #f00; color: white; padding: 2px; display: inline-block; font-weight: bold;">6</div> <table border="1" style="width: 100%; border-collapse: collapse;"> <tr> <td style="width: 33%; padding: 5px;"> Zum Ausschalten SET-Taster für 1 s gedrückt halten. </td> <td style="width: 33%; padding: 5px;"> Hold down the SET button for 1 s to switch off. </td> <td style="width: 33%; padding: 5px;"> Mantener pulsado el pulsador SET durante 1 s para apagar. </td> </tr> </table>	Zum Ausschalten SET-Taster für 1 s gedrückt halten.	Hold down the SET button for 1 s to switch off.	Mantener pulsado el pulsador SET durante 1 s para apagar.	ON ► OFF				 OFF
Zum Ausschalten SET-Taster für 1 s gedrückt halten.	Hold down the SET button for 1 s to switch off.	Mantener pulsado el pulsador SET durante 1 s para apagar.							
	<div style="background-color: #f00; color: white; padding: 2px; display: inline-block; font-weight: bold;">7</div> <table border="1" style="width: 100%; border-collapse: collapse;"> <tr> <td style="width: 33%; padding: 5px;"> Bei Leerstand LC-Wechsel durchführen und neues Batterieset einlegen. </td> <td style="width: 33%; padding: 5px;"> Replace LC when empty and insert a new battery pack. </td> <td style="width: 33%; padding: 5px;"> Si la unidad LC está vacía, se ha de cambiar e insertar un juego de pilas nuevo. </td> </tr> </table>	Bei Leerstand LC-Wechsel durchführen und neues Batterieset einlegen.	Replace LC when empty and insert a new battery pack.	Si la unidad LC está vacía, se ha de cambiar e insertar un juego de pilas nuevo.		 19 - 20	<div style="border: 1px solid black; padding: 5px; margin-bottom: 5px;"> C Batterieset (nicht wiederverwendbar) Battery pack (not re-usable) Juego de pilas (no reutilizable) </div> <div style="border: 1px solid black; padding: 5px;"> B LC befüllt (nicht wiederbefüllbar) Filled LC (not refillable) LC llenado (no rellenable) </div>		 ON
Bei Leerstand LC-Wechsel durchführen und neues Batterieset einlegen.	Replace LC when empty and insert a new battery pack.	Si la unidad LC está vacía, se ha de cambiar e insertar un juego de pilas nuevo.							

	8 – 10		18		OK	OK			
	<p>8</p> <table border="1"> <tr> <td data-bbox="360 416 539 491">Spenden werden durch „ru“ gekennzeichnet.</td> <td data-bbox="539 416 719 491">Discharges are identified by “ru”.</td> <td data-bbox="719 416 898 491">Las dosificaciones vienen identificadas por “ru”.</td> </tr> </table>	Spenden werden durch „ru“ gekennzeichnet.	Discharges are identified by “ru”.	Las dosificaciones vienen identificadas por “ru”.	<p>RUN</p> 			<p>OK</p>   <p>U In Betrieb In operation En funcionamiento</p>	
Spenden werden durch „ru“ gekennzeichnet.	Discharges are identified by “ru”.	Las dosificaciones vienen identificadas por “ru”.							
	<p>9</p> <table border="1"> <tr> <td data-bbox="360 715 539 1002">Durch Drücken des SET-Tasters für 10 s wird die Sonderspende „PU“ aktiviert. Es folgen drei Spenden mit jeweils 2,0 cm³. Durch Drücken des SET-Tasters wird die Sonderspende abgebrochen.</td> <td data-bbox="539 715 719 1002">The additional discharge “PU” is activated by pressing the SET button for 10 s. Three discharges of 2.0 cm³ each take place. The additional discharge can be stopped by pressing the SET button.</td> <td data-bbox="719 715 898 1002">Pulsando el pulsador SET durante 10 s se activa la dosificación adicional “PU”. A continuación se producen tres dosificaciones con 2,0 cm³ cada una. Pulsando el pulsador SET se cancela la dosificación adicional.</td> </tr> </table>	Durch Drücken des SET-Tasters für 10 s wird die Sonderspende „PU“ aktiviert. Es folgen drei Spenden mit jeweils 2,0 cm ³ . Durch Drücken des SET-Tasters wird die Sonderspende abgebrochen.	The additional discharge “PU” is activated by pressing the SET button for 10 s. Three discharges of 2.0 cm ³ each take place. The additional discharge can be stopped by pressing the SET button.	Pulsando el pulsador SET durante 10 s se activa la dosificación adicional “PU”. A continuación se producen tres dosificaciones con 2,0 cm ³ cada una. Pulsando el pulsador SET se cancela la dosificación adicional.	<p>PURGE</p> 			 	
Durch Drücken des SET-Tasters für 10 s wird die Sonderspende „PU“ aktiviert. Es folgen drei Spenden mit jeweils 2,0 cm ³ . Durch Drücken des SET-Tasters wird die Sonderspende abgebrochen.	The additional discharge “PU” is activated by pressing the SET button for 10 s. Three discharges of 2.0 cm ³ each take place. The additional discharge can be stopped by pressing the SET button.	Pulsando el pulsador SET durante 10 s se activa la dosificación adicional “PU”. A continuación se producen tres dosificaciones con 2,0 cm ³ cada una. Pulsando el pulsador SET se cancela la dosificación adicional.							
	<p>10</p> <table border="1"> <tr> <td data-bbox="360 1150 539 1453">Durch Drücken des SET-Tasters für 1 s erscheint die gewählte Einstellung. Nach Loslassen des SET-Tasters werden im Wechsel 10 s lang „rd“ und die Anzahl der Tage angezeigt, seitdem das Ereignis anliegt.</td> <td data-bbox="539 1150 719 1453">Hold down the SET button for 1 s to display the selected setting. When you release the SET button, “rd” and the number of days since the last event are displayed alternately for 10 s.</td> <td data-bbox="719 1150 898 1453">Pulsando el pulsador SET durante 1 s se muestra el ajuste seleccionado. Después de soltar el pulsador SET durante el cambio, se muestran alternativamente durante 10 s “rd” y la cantidad de días desde el inicio del evento.</td> </tr> </table>	Durch Drücken des SET-Tasters für 1 s erscheint die gewählte Einstellung. Nach Loslassen des SET-Tasters werden im Wechsel 10 s lang „rd“ und die Anzahl der Tage angezeigt, seitdem das Ereignis anliegt.	Hold down the SET button for 1 s to display the selected setting. When you release the SET button, “rd” and the number of days since the last event are displayed alternately for 10 s.	Pulsando el pulsador SET durante 1 s se muestra el ajuste seleccionado. Después de soltar el pulsador SET durante el cambio, se muestran alternativamente durante 10 s “rd” y la cantidad de días desde el inicio del evento.	<p>DAYS SINCE RED</p>	 		<p>18 DAYS SINCE RED</p> 	
Durch Drücken des SET-Tasters für 1 s erscheint die gewählte Einstellung. Nach Loslassen des SET-Tasters werden im Wechsel 10 s lang „rd“ und die Anzahl der Tage angezeigt, seitdem das Ereignis anliegt.	Hold down the SET button for 1 s to display the selected setting. When you release the SET button, “rd” and the number of days since the last event are displayed alternately for 10 s.	Pulsando el pulsador SET durante 1 s se muestra el ajuste seleccionado. Después de soltar el pulsador SET durante el cambio, se muestran alternativamente durante 10 s “rd” y la cantidad de días desde el inicio del evento.							

4.0 Installation Installation Instalación

4.1 Anbau Mounting Montaje

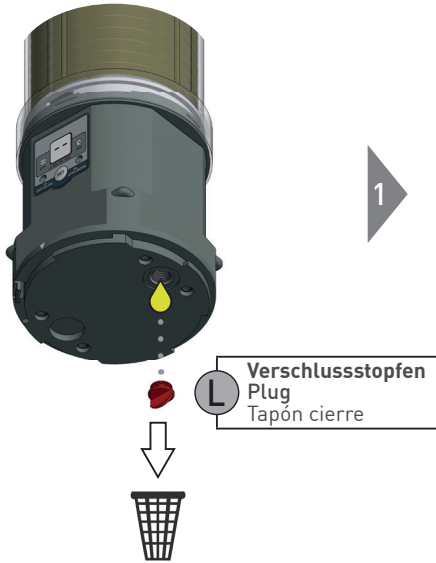

L Verschlussstopfen
Plug
Tapón cierre

M Fetthaltiger Abfall
Oil containing waste
Residuos con grasa

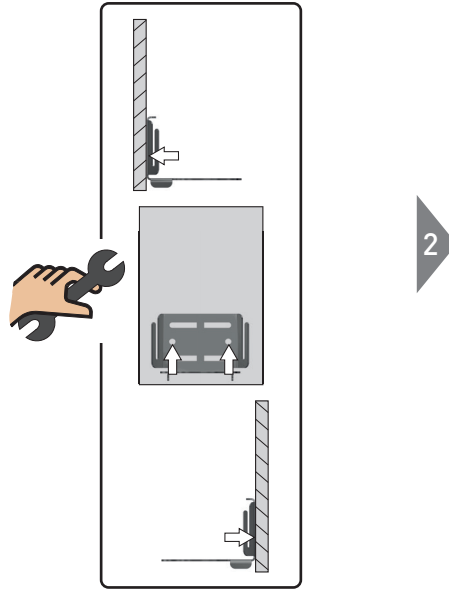

11 Montage auf
Montage-
halterung

Mount on
mounting
bracket

Montaje en
soporte de
montaje

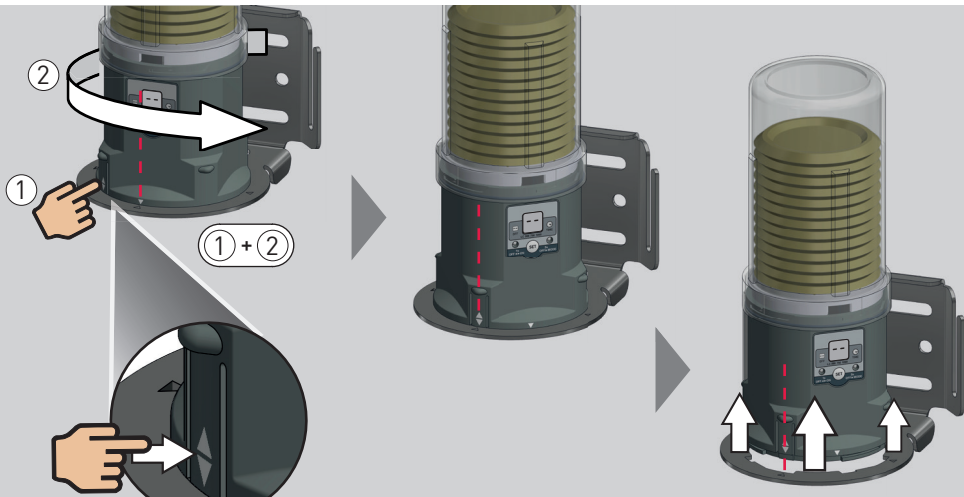
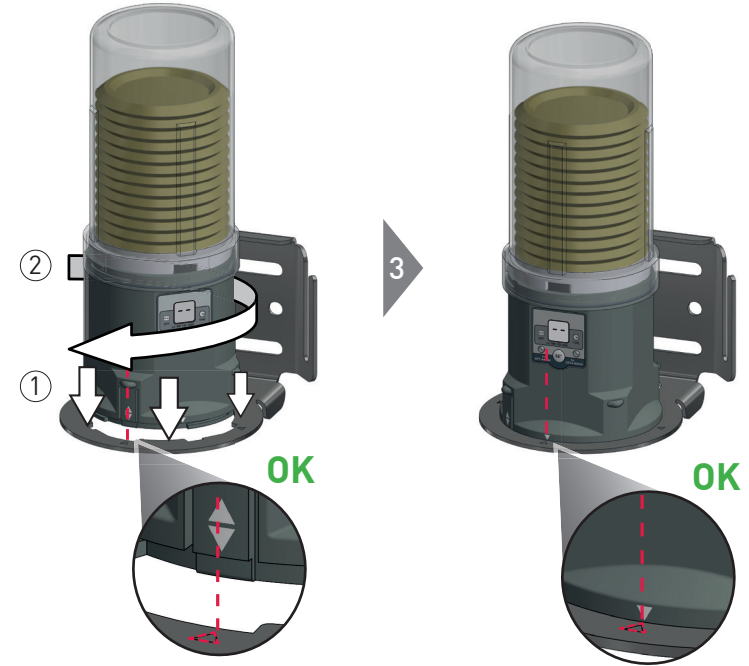
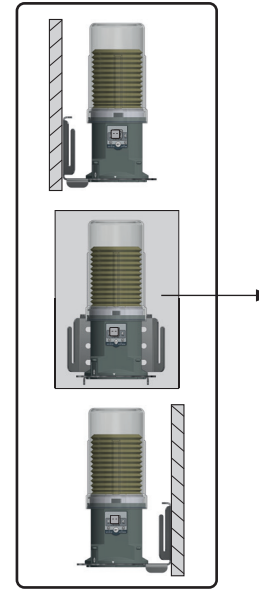

12 Demontage von Montage-
halterung durch gleichzeitiges
Drücken ① und Drehen ②

Remove from mounting
bracket by pressing ① and
turning ② simultaneously

Desmontaje del soporte de
montaje mediante presión ①
y roscado ② al mismo tiempo

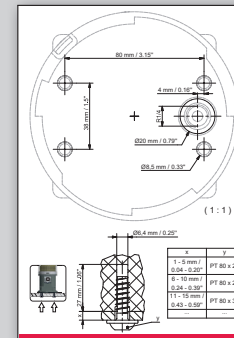
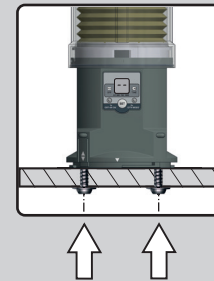

Y Bohrschablone
Drilling template
Plantilla para agujeros

50 - 51

13 Montage nach Bohrschablone

Mounting according to drill
template

Montaje según plantilla para
agujeros

4.2 Inbetriebnahme
Setting into operation
Puesta en marcha

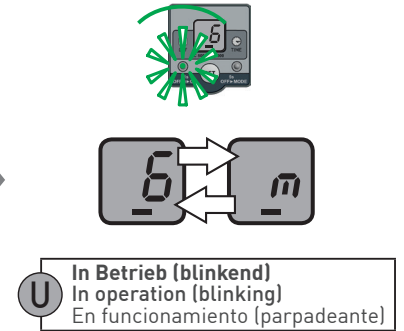
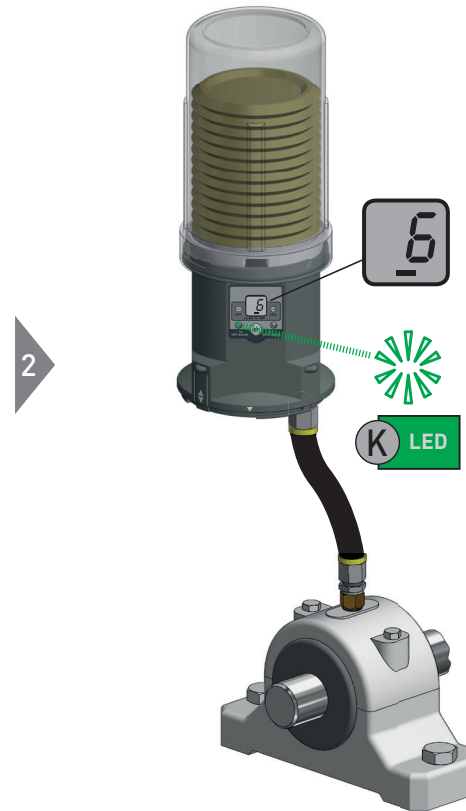
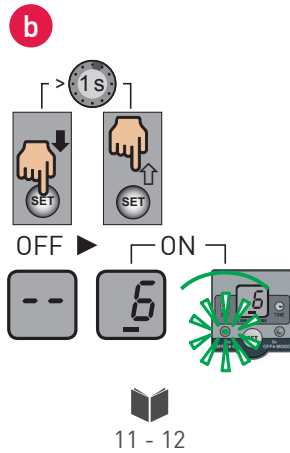
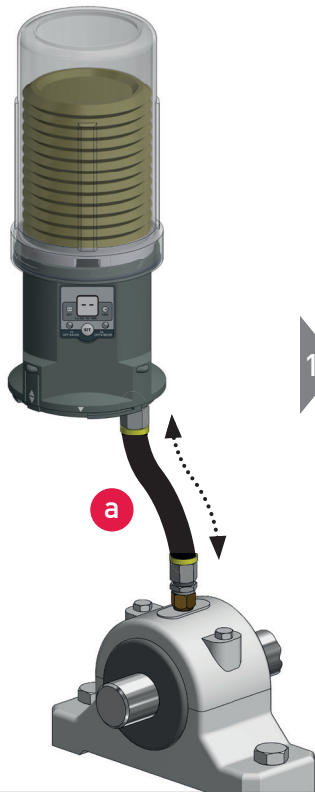
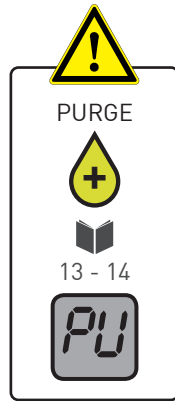

14

Bei Erstinbetriebnahme ist der Antrieb mit perma Food grade grease H1 SF10 vorgefüllt. Zum Austausch des Schmierstoffes im Antrieb die Sonder-spende PURGE (PU) auslösen, bis der in der LC enthaltene Schmierstoff am Auslass des Antriebes austritt.

During initial operation the drive is filled with perma Food grade grease H1 SF10. Please press PURGE (PU) in order to exchange the lubricant in the drive until the lubricant inside the LC is discharged at the drive outlet.

El motor está previamente relleno con el lubricante perma Food grade grease H1 SF10. Para cambiar el lubricante en el motor, activar la opción de dosificación especial de PURGE (PU) hasta que el lubricante incluido en el LC salga por la salida del motor.

a Schmier-system mit vorbereiteter Schmierstelle verbinden.

Connect lubrication system to primed lubrication point.

Unir el sistema de lubricación con el punto de lubricación preparado.

b Zum Einschalten SET-Taster für 1 s gedrückt halten.

Hold down the SET button for 1 s to switch on.

Mantener pulsado el pulsador SET durante 1 s para encender.

c Bei rauen Umgebungsbedingungen Schutz-kappe Heavy Duty auf das Schmier-system setzen und andrehen.

For rough environments place protection cap Heavy Duty over lubrication system and turn slightly.

En caso de condiciones adversas, colocar la tapa protectora Heavy Duty encima del sistema de lubricación y enroscarla.

c

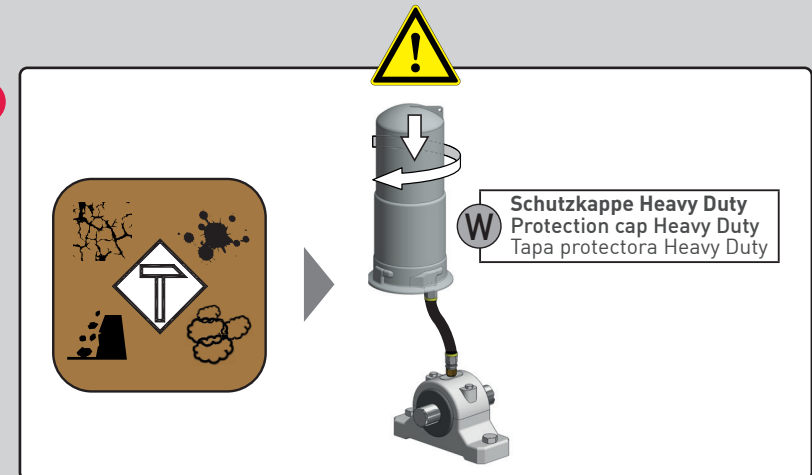

5.0 LC-Wechsel LC exchange Cambio LC



15

Rot blinkende LED und Anzeige „LC“ im Display signalisieren einen fälligen LC-Wechsel. Deckel abdrehen und abnehmen.

A flashing red LED and "LC" displayed on the screen indicate that an LC needs to be replaced. Unscrew and remove cover.

El LED rojo parpadeante y la visualización de "LC" en la pantalla indican que se debe cambiar el LC. Desensrosar la tapa y retirarla.



16

LC abziehen und entsorgen.

Remove and dispose of LC.

Retirar la unidad LC y desecharla.

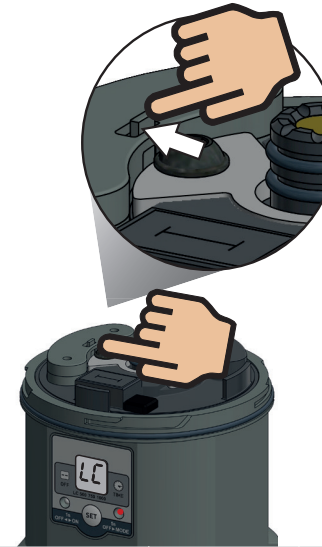

17

Batterieset entriegeln.

Release the battery pack.

Destrabar el juego de pilas.

18

Batterieset aus Antrieb entfernen und entsorgen.

Remove the battery pack from the drive and dispose of it.

Retirar el juego de pilas del motor y desechar.

C Batterieset (nicht wiederverwendbar)
Battery pack (not re-usable)
Juego de pilas (no reutilizable)

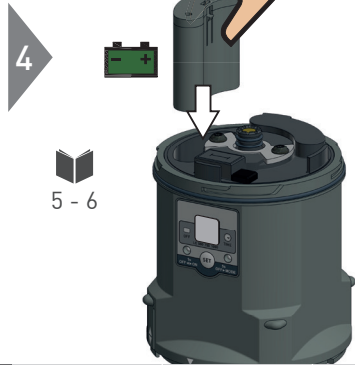

19

Neues Batterieset in den Antrieb einsetzen.

Insert a new battery pack into the drive.

Introducir el nuevo juego de pilas batería en la motor.

20

Batterieset einrasten.

Click the battery pack into place.

Encajar el juego de pilas.

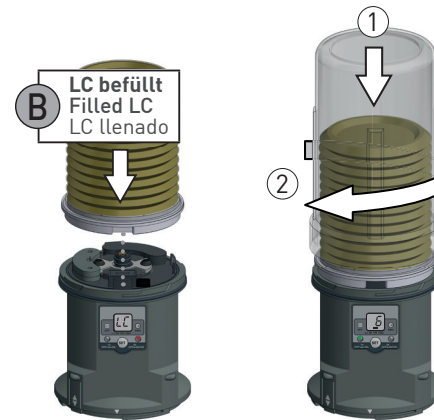

21

Neue LC aufsetzen. Deckel und Antrieb verschrauben. Schmier-system ist wieder ein-satzfähig.

Add new LC. Screw to-gether cover and drive. Lubrication system is op-erable again.

Colocar una unidad LC nueva. Enroscar tapa y motor. El sistema de lubricación está de nuevo listo para ser usado.

22

Die zuletzt vorhandene Einstellung wird übernommen.





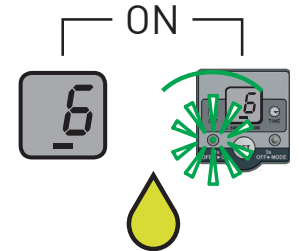

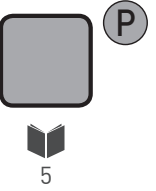
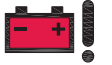

The last active setting is applied.

Se aplica la última configuración existente.

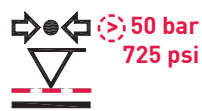
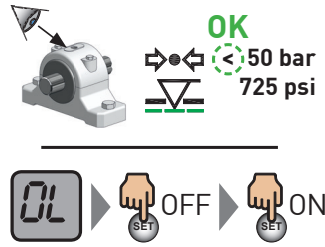









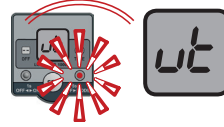

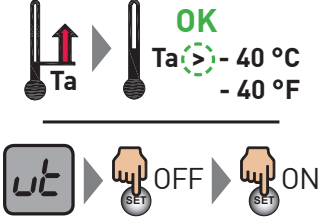



6.0 Fehlerbehebung Troubleshooting Solución de problemas

23 a - c

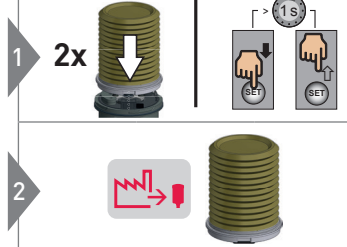
Fehler Error / Error			Ursache Cause / Causa			Abhilfe Corrective action / Solución			
			1						
			2						
a	Keine Anzeige im Display bei eingelegetem Batterie-set	No display when battery pack is inserted	No hay indicación en la pantalla con el juego de pilas insertado	Batterie-set leer	Battery pack empty	Juego de pilas vacío	Neues Batterie-set einsetzen	Insert a new battery pack	Insertar un juego de pilas nuevo
			Antrieb defekt	Drive defective	Motor defectuoso	Antrieb ersetzen	Replace drive	Sustituir el motor	
									
									
b	LED blinkt rot / Anzeige „OL“	LED flashing red / "OL" displayed	LED parpadea en rojo / se visualiza "OL"	Gegendruck übersteigt über längeren Zeitraum 50 bar	Counter-pressure exceeds 50 bar for a long time	La contrapresión supera los 50 bar durante un periodo de tiempo prolongado	Blockaden lösen ⇒ Gegendruck < 50 bar, SET-Taster betätigen	Remove blockages ⇒ counter-pressure < 50 bar, press SET button	Eliminar obstrucciones ⇒ Contrapresión < 50 bar, pulsar el pulsador SET
									
									
c	LED blinkt rot / Anzeige „Lo“	LED flashing red / "Lo" displayed	LED parpadea en rojo / se visualiza "Lo"	Batterie-set wurde mehrfach verwendet	Battery pack has been used multiple times	El juego de pilas ha sido usada varias veces	Neues Batterie-set einsetzen	Insert a new battery pack	Insertar un juego de pilas nuevo

23 d - f

Fehler Error / Error			Ursache Cause / Causa			Abhilfe Corrective action / Solución			
									
									
d	LED blinkt rot / Anzeige „ut“	LED flashing red / "ut" displayed	LED parpadea en rojo / se visualiza "ut"	Zulässige Temperatur über längeren Zeitraum unterschritten	Permitted temperature undershot for a long time	La temperatura permitida no se ha alcanzado durante un periodo prolongado	Zulässige Temperatur einhalten, SET-Taster betätigen	Maintain permitted temperature, press SET button	Mantener la temperatura permitida, pulsar el pulsador SET
									
									
e	LED blinkt rot / Anzeige „Er“	LED flashing red / "Er" displayed	LED parpadea en rojo / se visualiza "Er"	Antriebsmotor defekt	Drive motor defective	Motor de accionamiento defectuoso	Antrieb ersetzen	Replace drive	Sustituir el motor
									
									
f	LC ist aufgesetzt / Anzeige „LC“	LC attached / "LC" displayed	La unidad LC está colocada / se visualiza "LC"	Antrieb hat LC nicht erkannt	Drive does not recognize LC	El motor no ha reconocido la unidad LC	LC nochmals aufsetzen oder SET-Taster 1 s lang betätigen.	Attach LC again or press SET button for 1 s	Volver a colocar la unidad LC o presionar el pulsador SET durante 1 segundo.
									
			LC ersetzen	Replace LC	Cambiar la unidad LC				

7.0 Entsorgung Waste disposal Eliminación de residuos

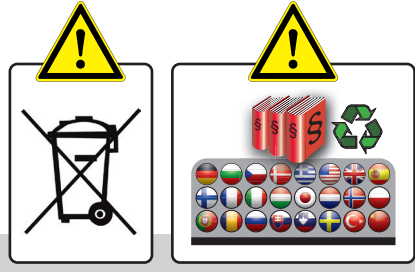

C Batterieset (nicht wiederverwendbar)
Battery pack (not re-usable)
Juego de pilas (no reutilizable)

Batterieentsorgung
Battery disposal
Eliminación de baterías

RECHARGE

V LC leer
Empty LC
LC vacío

M Fetthaltiger Abfall
Oil containing waste
Residuos con grasa

D Antrieb (wiederverwendbar)
Drive (re-usable)
Motor (reutilizable)

19 - 20

24

Antrieb nach Ende der Lebensdauer der Wiederverwertung zuführen.
Drive is to be recycled at the end of its service life.
Reciclar el motor una vez finalizada su vida útil.

8.0 Kennzeichnung Markings Distintivo

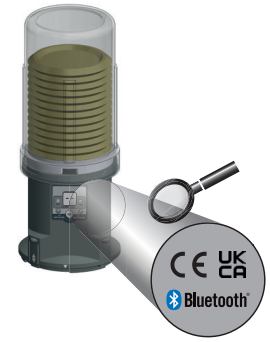

Model: ULTRA
Contains FCC ID RFR-S50
Contains IC 4957A-S50

This device complies with part 15 of the FCC Rules and Innovation, Science and Economic Development Canada (ISED) license-exempt RSS standard(s). Operation is subject to the following two conditions:
(1) This device may not cause harmful interference, and (2) this device must accept any interference received, including interference that may cause undesired operation.

Le présent appareil est conforme aux CNR Innovation, Sciences et Développement économique Canada applicables aux appareils radio exempts de licence. L'exploitation est autorisée aux deux conditions suivantes:
(1) l'appareil ne doit pas produire de brouillage, et (2) l'utilisateur de l'appareil doit accepter tout brouillage radioélectrique subi, même si le brouillage est susceptible d'en compromettre le fonctionnement.

FCC § 15.21 Information to user
Changes or modifications not expressly approved by the party responsible for compliance could void the user's authority to operate the equipment.

RF Exposure Requirements
To comply with FCC RF exposure compliance requirements, the device must be installed to provide a separation distance of at least 20 cm from all persons.

CCA423LP1770T7

取得審驗證明之低功率射頻器材，非經核准，公司、商號或使用者均不得擅自變更頻率、加大功率或變更原設計之特性及功能。低功率射頻器材之使用不得影響飛航安全及干擾合法通信；經發現有干擾現象時，應立即停用，並改善至無干擾時方得繼續使用。前述合法通信，指依電信管理法規作業之無線電通信。低功率射頻器材須忍受合法通信或工業、科學及醫療用電波輻射性電機設備之干擾。

EAC

T005 23

TDR
ER94400/21
United Arab Emirates

Complies with IMDA Standards DA105282

ETA-SD-20210100411

ICASA
TA-2020/7932

ANATEL
Agência Nacional de Telecomunicações
03144-21-13767

IFT: RCPPEUL21-3777

NOM **NYCE**

La operación de este equipo está sujeta a las siguientes dos condiciones:
(1) es posible que este equipo o dispositivo no cause interferencia perjudicial y
(2) este equipo o dispositivo debe aceptar cualquier interferencia, incluyendo la que pueda causar su operación no deseada.



EG/EU-Konformitätserklärung nach Richtlinie 2006/42/EG und Richtlinie 2014/53/UE	Déclaration CE/UE de conformité selon la directive 2006/42/CE et directive 2014/53/UE	Declaración CE/UE de conformidad según la directiva 2006/42/CE y directiva 2014/53/UE	Dichiarazione di conformità CE/UE secondo la direttiva 2006/42/CE e direttiva 2014/53/UE	EC/EU Declaration of Conformity according to Directive 2006/42/EC and Directive 2014/53/EU	UKCA Declaration of Conformity according to Supply of Machinery (Safety) Regulations 2008 and Radio Equipment Regulations 2017
---	--	--	---	---	---

**perma-tec GmbH & Co. KG
Hammelburger Straße 21
97717 Euerdorf
GERMANY**

Der Hersteller erklärt hiermit, dass das bezeichnete Produkt in den gelieferten Ausführungen den Bestimmungen der oben gekennzeichneten Richtlinien - einschließlich derer zum Zeitpunkt der Erklärung geltenden Änderungen - entspricht.	Le fabricant déclare par la présente que le produit désigné dans sa version livrée est conforme aux dispositions des directives citées ci-dessus - ainsi qu'aux modifications en vigueur au moment de la certification.	Por la presente el fabricante declara, que todas las versiones disponibles de este producto se ajustan a las directivas arriba indicadas, incluyendo los cambios que se produzcan al tiempo de emitir esta declaración.	Il produttore con la presente dichiara che il prodotto designato nei modelli consegnati è conforme alle disposizioni delle norme sopra riportate, incluse le variazioni valide al momento della dichiarazione.	The manufacturer hereby declares that the product as described in the given statement conforms to the regulations appertaining to the directives referred to above, including any amendments thereto which are in force at the time of the declaration.
---	---	---	--	---

In der Gemeinschaft ansässige Person, die bevollmächtigt ist, die relevanten technischen Unterlagen zusammenzustellen:	Personne établie dans la Communauté autorisée à établir le dossier technique pertinent:	Persona con residencia en la Comunidad que está autorizada a crear los pertinentes documentos técnicos:	Persona residente nella Comunità autorizzata a raccogliere la documentazione tecnica necessaria:	Person residing within the Community authorised to compile the relevant technical documentation:	UK authorized representative:
---	--	--	---	---	--------------------------------------

perma-tec GmbH & Co. KG Hammelburger Straße 21 97717 Euerdorf GERMANY	Daniel Gogola 25 Barnfield, East Allington, Totnes DEVON TQ9 7QR UNITED KINGDOM
--	---

Produktbezeichnung:	Désignation:	Tipo de producto:	Descrizione del prodotto:	Product description:
Automatisches Schmieresystem	Système de lubrification automatique	Sistema de lubricación automático	Sistema di lubrificazione automatica	Automatic lubrication system
Produktname:	Nom du produit:	Denominación producto:	Nome del prodotto:	Product name:

ULTRA

Typ:	Type:	Tipo:	Tipo:	Type:
------	-------	-------	-------	-------

500 750 1000

Folgende harmonisierte Normen wurden angewandt:	Les normes associées suivantes ont été utilisées:	Se han aplicado las siguientes normas de armonización:	Sono state recepite le seguenti norme di standardizzazione:	The following harmonised / designated standards were applied:
---	---	--	---	---

EN ISO 12100:2010
EN 62368-1:2014 + A11:2017, EN 62311:2008, ETSI EN 300328 V2.2.2:2019, EN 301489-1 V2.2.3:2019, EN 301489-17 V3.2.4:2020

Dr. Abassin Aryobsei, CEO

Dr. Matthias Lenhart, Technical Director

Euerdorf, 27 March 2023



	Deutsch	de	27 - 28
	English	en	29 - 30
	Español	es	31 - 32
	Français	fr	33 - 36
	Italiano	it	37 - 40
	Português	pt	41 - 44
	Русский	ru	45 - 48

⚠ = Achtung Gefahr

Damit vom Schmiersystem keine Gefahren ausgehen, muss der Betreiber gewährleisten:

- dass nur qualifiziertes Personal an und mit dem Schmiersystem arbeitet;
- dass das Personal die Betriebsanleitung bei allen entsprechenden Arbeiten verfügbar hat und sich an diese hält;
- dass bei der Montage oder bei Wartungsarbeiten die notwendigen Unfallverhütungs- und Sicherheitsvorschriften eingehalten werden;
- dass das Schmiersystem sachgerecht und bestimmungsgemäß verwendet wird und nicht falsch eingestellt oder variiert wird.

Sicherheitsdatenblätter der Öle und Fette beachten.

Kontakt mit Augen, Haut und Kleidung durch Öl / Fett und Verschlucken von Öl / Fett vermeiden.



Öl / Fett nicht ins Erdreich oder in die Kanalisation gelangen lassen.

Öl / Fett auf Verkehrswegen führt zu erhöhter Rutschgefahr. Boden sofort mit entsprechenden Mitteln reinigen.

Batterien:

Nicht wiederverwenden!



Nicht öffnen!



Nicht ins Feuer werfen!



Nicht aufladen!

i = Hinweis, Tipp

Schmierstoffdatenblätter können über unsere Homepage oder vom lokalen Händler bezogen werden.

Es wird keine Haftung für Schäden und Betriebsstörungen übernommen, die durch sachwidrige Verwendung und durch unsachgemäßes Arbeiten an und mit dem Schmiersystem entstehen.

Das Schmiersystem entspricht zum Zeitpunkt der Auslieferung dem Stand der Technik und gilt grundsätzlich als betriebssicher.

Aufgrund ständiger Produktentwicklung behalten wir uns das Recht vor, Produktänderungen, welche die Funktion des Produktes nicht beeinflussen, ohne vorherige Mitteilung vorzunehmen.



Schützen Sie die Umwelt, indem Sie wertvolle Rohstoffe der Wiederverwertung zuführen. Beachten Sie die jeweiligen Entsorgungsrichtlinien Ihres Landes.

- Ⓐ Deckel (wiederverwendbar)
- Ⓑ LC befüllt (nicht wiederbefüllbar)
- Ⓒ Batterieset (nicht wiederverwendbar)
- Ⓓ Antrieb (wiederverwendbar)
- Ⓔ Lagerungsbedingungen
- Ⓕ Einsatztemperatur
- Ⓖ1 Alkali-Mangan
- Ⓖ2 Lithium
- Ⓗ Spendezeit
- Ⓘ Einbaulage
- Ⓙ Luftschallemission
- Ⓚ LED
- Ⓛ Verschlussstopfen
- Ⓜ Fetthaltiger Abfall
- Ⓝ Installations- / Wechseldatum
- Ⓞ Transportsicherung
- Ⓟ Display
- Ⓠ SET-Taster
- Ⓡ Spendemenge
- Ⓢ SET-Taster gedrückt halten
- Ⓣ SET-Taster loslassen
- Ⓤ In Betrieb (blinkend)
- Ⓥ LC leer
- Ⓦ Schutzkappe Heavy Duty
- Ⓧ Batterieentsorgung
- Ⓨ Bohrschablone

1.0 Eigenschaften**2.0 Teile / Erstmontage****3.0 Bedienung**

3.1 Anzeigen

3.2 Konfiguration

3.3 Betriebszustände

4.0 Installation

4.1 Anbau

4.2 Inbetriebnahme

5.0 LC-Wechsel**6.0 Fehlerbehebung**

Fehler

Ursache

Abhilfe

7.0 Entsorgung**8.0 Kennzeichnung**

Die Anleitung dient zum sicheren Arbeiten an und mit dem automatischen Schmiersystem, das zum Einsatz in Maschinen und Anlagen bestimmt ist und das Wälz- und Gleitlager, Ketten, Führungen, offene Getriebe etc. mit Fett schmiert.

Überprüfen Sie sofort nach Erhalt der Lieferung, ob diese mit Ihrer Bestellung übereinstimmt. Für nachträglich reklamierte Mängel wird keine Gewährleistung übernommen.

Bei Fragen und Problemen wenden Sie sich bitte an unseren Kundendienst oder an den lokalen Händler.

**⚠ = Attention: Danger**

To prevent the lubrication system from posing any risks, the operator must ensure that:

- only qualified personnel work on and with the lubrication system;
- personnel keep the Operating Instructions to hand when carrying out all relevant work and comply with them;
- the necessary accident prevention and safety regulations are adhered to during installation or maintenance work;
- the lubrication system is used properly and in accordance with its intended purpose and is not incorrectly adjusted or modified.

Observe safety data sheets of oil / grease.

Avoid contact of oil / grease with eyes, skin and clothing; also avoid swallowing of oil / grease.



Prevent oil / grease from getting into soil or sewer system.

Oil / grease on traffic routes will increase the risk of slipping. Clean the floor immediately using appropriate cleaning agents.

Batteries:

Do not reuse!



Do not open!



Do not expose to fire!



Do not charge!

i = Note, tip

You may download lubricant data sheets from our web site or ask your local supplier.

We accept no liability for any damages and malfunctions which are caused by inappropriate usage and inappropriate operations on or with the lubricator.

At the time of delivery, the lubrication system corresponds to the state of the art and, as a basic principle, is considered safe to operate.

Because of constant product improvements, we reserve the right to make product changes which do not alter the function of the product, without prior notice.



Protect the environment by recycling valuable raw material according to local regulations.

- Ⓐ Cover (re-usable)
- Ⓑ Filled LC (not refillable)
- Ⓒ Battery pack (not re-usable)
- Ⓓ Drive (re-usable)
- Ⓔ Storage conditions
- Ⓕ Operating temperature
- Ⓖ1 Alkaline manganese
- Ⓖ2 Lithium
- Ⓗ Discharge period
- Ⓘ Shaft orientation
- Ⓙ Airborne noise emission
- Ⓚ LED
- Ⓛ Plug
- Ⓜ Oil containing waste
- Ⓝ Installation / Exchange date
- Ⓞ Transport lock
- Ⓟ Display
- Ⓠ SET button
- Ⓡ Discharge amount
- Ⓢ Hold down SET button
- Ⓣ Release SET button
- Ⓤ In operation (blinking)
- Ⓥ Empty LC
- Ⓦ Protection cap Heavy Duty
- Ⓧ Battery disposal
- Ⓨ Drilling template

1.0 Properties**2.0 Components / Initial assembly****3.0 Handling**

- 3.1 Displays
- 3.2 Configuration
- 3.3 Operating states

4.0 Installation

- 4.1 Mounting
- 4.2 Setting into operation

5.0 LC exchange**6.0 Troubleshooting**

- Error
- Cause
- Corrective action

7.0 Waste disposal**8.0 Markings**

This manual helps ensure safe working on and with the automatic lubrication system, which is designed for use in machinery and equipment and which lubricates roller and sliding bearings, chains, sliding guideways, open gears, etc. with grease.

Upon delivery, make sure to check that the delivered goods correspond to your order. No liability is accepted for subsequent claims of any defects.

If you have any questions or problems, please contact our customer service team or your local supplier.

**⚠ = Atención, peligro**

Para que el sistema de lubricación no suponga ningún peligro, el operario debe asegurarse de que:

- solo se permita a personal cualificado trabajar con el sistema de lubricación o junto a él;
- el personal tenga a su disposición el manual de instrucciones y lo siga;
- durante el montaje y mantenimiento se cumpla la normativa vigente sobre seguridad y prevención de accidentes;
- el sistema de lubricación se use de manera profesional y adecuada y no se ajuste incorrectamente ni se modifique.

Observar las hojas de datos de seguridad de los aceites y grasas.

Evitar el contacto de aceite / grasa con los ojos, la piel y la vestimenta, así como la ingestión de aceite / grasa.



No permitir que el aceite / la grasa llegue a la tierra ni al alcantarillado.

La presencia de aceite o grasa en las vías de circulación eleva el riesgo de resbalar. Limpiar el suelo inmediatamente con el producto adecuado.

Baterías:

¡No las reutilice!



¡No las abra!



¡No las arroje al fuego!



¡No las cargue!

i = Nota, consejo

Las hojas de datos de los lubricantes se pueden obtener en nuestra página principal o a través del distribuidor local.

No se asumirá la garantía por aquellos daños y anomalías de funcionamiento que se originen por haber utilizado inapropiadamente o por haber trabajado inadecuadamente en o con el sistema de lubricación.

El sistema de lubricación responde a la técnica más avanzada en el momento de su entrega y, por tanto, en principio se considera seguro para su uso.

Debido al continuo desarrollo de los productos, nos reservamos el derecho a realizar sin previo aviso cualquier modificación en los productos que no afecte a su funcionamiento.



Proteja el medio ambiente reciclando los materiales que puedan tener valor. Tenga en cuenta las directrices de eliminación de residuos pertinentes en su país.

- A Tapa (reutilizable)
- B LC llenado (no rellenable)
- C Juego de pilas (no reutilizable)
- D Motor (reutilizable)
- E Condiciones de almacenamiento
- F Temperatura de aplicación
- G1 Alcalina de manganeso
- G2 Litio
- H Tiempo de dosificación
- I Posición de instalación
- J Emisión de ruido aéreo
- K LED
- L Tapón cierre
- M Residuos con grasa
- N Fecha de instalación / cambio
- O Cierre de transporte
- P Pantalla
- Q Pulsador SET
- R Cantidad de dosificación
- S Mantener pulsado el pulsador SET
- T Soltar el pulsador SET
- U En funcionamiento (parpadeante)
- V LC vacío
- W Tapa protectora Heavy Duty
- X Eliminación de baterías
- Y Plantilla para agujeros

1.0 Características**2.0 Piezas / Primer montaje****3.0 Manejo**

3.1 Indicadores

3.2 Configuración

3.3 Estados de servicio

4.0 Instalación

4.1 Montaje

4.2 Puesta en marcha

5.0 Cambio LC**6.0 Solución de problemas**

Error

Causa

Solución

7.0 Eliminación de residuos**8.0 Distintivo**

Las instrucciones sirven para trabajar con seguridad en y con el sistema de lubricación automática, indicado para su uso en máquinas y equipos y que, usando grasa, lubrica rodamientos, cojinetes de deslizamiento, cadenas, guías, engranajes abiertos, etc.

En el momento de recibir el pedido, compruebe inmediatamente si coincide con lo solicitado. No se aceptará ningún tipo de garantía por los defectos reclamados a posteriori.

Si tiene alguna duda o problema, diríjase a nuestro servicio de atención al cliente o a su distribuidor local.

⚠ = Attention danger

Afin d'éviter tout risque émanant du système de lubrification, l'exploitant doit garantir:

- que seul du personnel qualifié travaille sur le système de lubrification;
- que le personnel dispose du manuel opérateur pour tous les travaux concernés et qu'il s'y conforme;
- que les prescriptions de sécurité ont été respectées pour le montage et les travaux de maintenance;
- que le système de lubrification est utilisé correctement et de façon conforme et qu'il n'est pas mal réglé ou modifié.

Respecter les fiches techniques de sécurité des huiles et des graisses.

Éviter le contact de l'huile / de la graisse avec les yeux, la peau et les vêtements et éviter l'ingestion d'huile / de graisse.



L'huile / la graisse ne doit pas pénétrer dans le sol ou dans la canalisation.

De l'huile / de la graisse sur les chemins entraîne un risque de dérapage élevé. Nettoyer le sol immédiatement avec les moyens adéquats.

Piles:

Ne pas recycler!



Ne pas ouvrir!



Ne pas jeter les piles au feu!



Ne pas recharger!

i = Conseil, astuce

Les fiches de données des lubrifiants sont téléchargeables sur notre site web ou peuvent être demandées auprès du service commercial.

Nous ne pouvons pas être tenus responsables de dommages et dérangements résultant d'une utilisation non conforme et d'un mode de travail non correct avec et du système de lubrification.

Au moment de sa livraison, le système de lubrification satisfait à l'état de la technique et est en parfait état de fonctionnement.

En raison du développement permanent de nos produits, nous nous réservons le droit d'apporter au produit des modifications sans préavis si celles-ci n'affectent pas le fonctionnement du produit.



Protégez l'environnement en vous assurant que les matières premières de valeur soient recyclées. Respectez les directives d'élimination des déchets en vigueur dans votre pays.

- A Couvercle (réutilisable)
- B LC rempli (non remplissable)
- C Jeu de piles (non réutilisable)
- D Moteur (réutilisable)
- E Conditions de stockage
- F Température de fonctionnement
- G1 Alcaline-manganèse
- G2 Lithium
- H Durée de distribution
- I Position de montage
- J Emission de bruit aérien
- K LED
- L Bouchon d'obturation
- M Déchets contenant de la graisse
- N Date de l'installation / remplacement
- O Fixation de sécurité pour le transport
- P Écran
- Q Touche SET
- R Quantité dispensée
- S Maintenir la touche SET enfoncée
- T Relâcher la touche SET
- U En service (clignotement)
- V LC vide
- W Capot de protection Heavy Duty
- X Élimination des piles
- Y Gabarit de perçage

1.0 Propriétés**2.0 Pièces / premier montage****3.0 Commande**

3.1 Affichages

3.2 Configuration

3.3 États de fonctionnement

4.0 Installation

4.1 Montage

4.2 Mise en service

5.0 Remplacement de la LC**6.0 Dépannage**

Erreur

Cause

Solution

7.0 Élimination**8.0 Identification**

Les instructions ont pour but d'assurer un travail en toute sécurité sur et avec le système de lubrification automatique, utilisé sur les machines et les installations et alimentant en graisse les paliers à roulement, les paliers lisses, les chaînes, les guidages et les engrenages ouverts, etc.

Vérifier au moment de la livraison que celle-ci est bien conforme à la commande. Aucune garantie n'est accordée pour les dommages réclamés ultérieurement.

Pour toute question ou en cas de problème, adressez-vous à notre service après-vente ou à votre revendeur local.

**Montage initial**

a	Insérer le jeu de piles dans le moteur et bien le mettre en place.	
b	Autotest automatique	
c	"LC" est affiché sur l'écran. Après 60 s, l'éclairage arrière s'éteint.	
1	d Enlever le bouchon d'obturation de du moteur et l'éliminer.	5
e	Tenir la LC par le bas. Enlever la fixation de sécurité pour le transport et le bouchon d'obturation et les éliminer. Appuyer légèrement sur la LC jusqu'à ce que le lubrifiant apparaisse à la sortie.	
f	Centrer la LC sur le moteur en l'orientant sur la languette avant et enclencher. La taille de la LC est détectée automatiquement.	
g	Poser le couvercle sur la LC et le visser jusqu'à enclenchement.	
2	La distribution de lubrifiant est synchronisée.	7
Régler l'unité de temps		
a	Pour le réglage initial ①, appuyer la touche SET pendant 1 s et pendant 5 s pour modifier le réglage ②.	
3	b L'affichage en roulement m/w apparaît.	9
c	Régler l'unité de temps (m,w) en appuyant sur la touche SET: 1x = m (mois) 2x = w (semaines)	
d	Après 3 s, la modification est appliquée (sans appuyer sur la touche SET).	
Régler la durée de distribution		
a	Réglage possible dès que les chiffres clignotent.	
4	b Régler la durée de distribution soit avec en appuyant une seule fois ou par appui prolongé (= faire défiler).	9
c	Après 3 s, la modification est appliquée (sans appuyer sur la touche SET).	
d	Une fois les paramètres acceptés, le système s'éteint.	
5	Maintenir la touche SET enfoncée pendant 1 s pour le démarrage.	11
6	Maintenir la touche SET enfoncée pendant 1 s pour éteindre.	11
7	Si le réservoir est vide, changer la LC et insérer un nouveau jeu de piles.	11
8	Les distributions sont marquées par "ru".	13
9	Il faut appuyer sur la touche SET pendant 10 s pour activer la distribution spéciale "PU". Ceci génère trois distributions de 2,0 cm ³ chacune. La distribution spéciale peut être interrompue en appuyant sur la touche SET.	13
10	Le réglage sélectionné apparaît en appuyant sur la touche SET pendant 1 s. Après avoir relâché la touche SET, "rd" et le nombre de jours depuis l'affichage de l'événement sont affichés alternativement pendant 10 s.	13
11	Montage sur support de montage	15
12	Démontage du support de montage en appuyant ① et en tournant ② simultanément	15

13	Montage selon le gabarit de perçage	16																											
	Lors de la première mise en service, le moteur est pré-rempli de perma Food grade grease H1 SF10. Pour remplacer la graisse contenue dans le moteur, effectuer le graissage spécial PURGE (PU) jusqu'à ce que le lubrifiant contenu dans la LC soit évacué à la sortie du moteur.																												
14	a Relier le système de lubrification avec le point de lubrification préparé.	17																											
b	Maintenir la touche SET enfoncée pendant 1 s pour le démarrage.																												
c	Dans des conditions ambiantes rudes, mettre le capot de protection Heavy Duty sur le système de lubrification et le visser.																												
15	Une LED rouge clignotante et l'affichage "LC" à l'écran signalent que la LC doit être changée. Dévisser le couvercle et l'enlever.	19																											
16	Retirer la LC et l'éliminer.	19																											
17	Déverrouiller le jeu de piles.	20																											
18	Retirer le jeu de piles du moteur et l'éliminer.	20																											
19	Insérer un nouveau jeu de piles dans le moteur.	19																											
20	Mettre le jeu de piles en place.	19																											
21	Poser une nouvelle LC. Visser le couvercle et le moteur. Le système de lubrification est à nouveau prêt à l'emploi.	20																											
22	Le dernier réglage existant est appliqué.	20																											
	<table border="1"> <thead> <tr> <th>Erreur</th> <th>Cause</th> <th>Solution</th> </tr> </thead> <tbody> <tr> <td>a</td> <td>Aucun affichage sur l'écran bien que le jeu de piles soit inséré</td> <td>Le jeu de piles est vide Moteur défectueux</td> <td>Insérer un nouveau jeu de piles Remplacer le moteur</td> </tr> <tr> <td>b</td> <td>La LED clignote en rouge / Affichage "OL"</td> <td>La contre-pression dépasse 50 bars pendant une longue période</td> <td>Débloquer les colmatages ⇒ Contre-pression < 50 bars, actionner la touche SET</td> </tr> <tr> <td>c</td> <td>La LED clignote en rouge / Affichage "Lo"</td> <td>Le jeu de piles a été utilisé plusieurs fois</td> <td>Insérer un nouveau jeu de piles</td> </tr> <tr> <td>d</td> <td>La LED clignote en rouge / Affichage "ut"</td> <td>Température admissible dépassée pendant une longue période</td> <td>Respecter la température admissible, actionner la touche SET</td> </tr> <tr> <td>e</td> <td>La LED clignote en rouge / Affichage "Er"</td> <td>Moteur d'entraînement défectueux</td> <td>Remplacer le moteur</td> </tr> <tr> <td>f</td> <td>La LC est posée / Affichage "LC"</td> <td>Le moteur n'a pas reconnu la LC</td> <td>Poser de nouveau la LC ou appuyer pendant 1 s sur la touche SET Remplacer la LC</td> </tr> </tbody> </table>	Erreur	Cause	Solution	a	Aucun affichage sur l'écran bien que le jeu de piles soit inséré	Le jeu de piles est vide Moteur défectueux	Insérer un nouveau jeu de piles Remplacer le moteur	b	La LED clignote en rouge / Affichage "OL"	La contre-pression dépasse 50 bars pendant une longue période	Débloquer les colmatages ⇒ Contre-pression < 50 bars, actionner la touche SET	c	La LED clignote en rouge / Affichage "Lo"	Le jeu de piles a été utilisé plusieurs fois	Insérer un nouveau jeu de piles	d	La LED clignote en rouge / Affichage "ut"	Température admissible dépassée pendant une longue période	Respecter la température admissible, actionner la touche SET	e	La LED clignote en rouge / Affichage "Er"	Moteur d'entraînement défectueux	Remplacer le moteur	f	La LC est posée / Affichage "LC"	Le moteur n'a pas reconnu la LC	Poser de nouveau la LC ou appuyer pendant 1 s sur la touche SET Remplacer la LC	
Erreur	Cause	Solution																											
a	Aucun affichage sur l'écran bien que le jeu de piles soit inséré	Le jeu de piles est vide Moteur défectueux	Insérer un nouveau jeu de piles Remplacer le moteur																										
b	La LED clignote en rouge / Affichage "OL"	La contre-pression dépasse 50 bars pendant une longue période	Débloquer les colmatages ⇒ Contre-pression < 50 bars, actionner la touche SET																										
c	La LED clignote en rouge / Affichage "Lo"	Le jeu de piles a été utilisé plusieurs fois	Insérer un nouveau jeu de piles																										
d	La LED clignote en rouge / Affichage "ut"	Température admissible dépassée pendant une longue période	Respecter la température admissible, actionner la touche SET																										
e	La LED clignote en rouge / Affichage "Er"	Moteur d'entraînement défectueux	Remplacer le moteur																										
f	La LC est posée / Affichage "LC"	Le moteur n'a pas reconnu la LC	Poser de nouveau la LC ou appuyer pendant 1 s sur la touche SET Remplacer la LC																										
23		21																											
24	Après la fin de sa durée de vie, le moteur doit être recyclé.	23																											

**⚠ = Attenzione: pericolo**

Per evitare che il sistema di lubrificazione sia causa di pericoli, l'operatore deve garantire che:

- solo personale qualificato lavori sul sistema di lubrificazione e con esso;
- il personale abbia a disposizione il manuale d'uso durante qualsiasi lavoro venga effettuato e si attenga alle istruzioni in esso contenute;
- el corso del montaggio o degli interventi di manutenzione siano rispettate le necessarie norme antinfortunistiche e di sicurezza;
- il sistema di lubrificazione venga utilizzato in modo appropriato e conformemente alle indicazioni e non sia impostato in modo errato né modificato.

Prestare attenzione alle schede tecniche di sicurezza di oli e grassi.

Evitare che l'olio / il grasso entri in contatto con occhi, pelle e abiti; non ingerire l'olio o il grasso.



Evitare che l'olio / il grasso penetri nel terreno o nel sistema fognario.

L'olio / il grasso sulle vie di comunicazione determina un elevato pericolo di scivolamento. Pulire immediatamente il suolo con strumenti e prodotti adeguati.

Batterie:

Non riutilizzare!



Non aprire!



Non gettare nel fuoco!



Non ricaricare!

i = Osservazione, suggerimento

Le schede dei lubrificanti si possono anche scaricare tramite la nostra homepage oppure richiedere al rivenditore locale.

Non si assume alcuna responsabilità per danni o anomalie di funzionamento dovuti un utilizzo improprio del sistema di lubrificazione o a interventi non appropriati eseguiti sullo stesso.

Al momento della consegna il sistema di lubrificazione è conforme allo stato della tecnica ed è da considerarsi in condizioni di utilizzo sicure.

I nostri prodotti sono soggetti ad uno sviluppo continuo, perciò ci riserviamo il diritto di apportare modifiche ai prodotti senza preavviso, a condizione che queste non influiscano sulla funzione dei prodotti stessi.



Tutelate l'ambiente avviando al riciclaggio le pregiate materie prime. Rispettate sempre le direttive sullo smaltimento vigenti nel vostro paese.

- Ⓐ Coperchio (riutilizzabile)
- Ⓑ LC pieno (non riempibile)
- Ⓒ Set batterie (non riutilizzabile)
- Ⓓ Azionamento (riutilizzabile)
- Ⓔ Condizioni di conservazione
- Ⓕ Temperatura di utilizzo
- Ⓖ1 Alcalina / manganese
- Ⓖ2 Litio
- Ⓗ Periodo di erogazione
- Ⓘ Posizione di montaggio
- Ⓝ Emissioni sonore in aria
- Ⓚ LED
- Ⓛ Tappo chiusura
- Ⓜ Rifiuti contenenti olio
- Ⓝ Data di installazione / sostituzione
- ⓓ Protezione di sicurezza per il trasporto
- Ⓟ Display
- Ⓠ Pulsante SET
- Ⓡ Quantità erogata
- Ⓢ Mantenere premuto il pulsante SET
- Ⓣ Lasciare il pulsante SET
- Ⓤ In funzione (lampeggiante)
- Ⓥ LC vuoto
- Ⓦ Cappuccio di protezione Heavy Duty
- Ⓧ Smaltimento della batteria
- Ⓨ Dima di foratura

1.0 Proprietà**2.0 Pezzi / Primo montaggio****3.0 Utilizzo azionamento**

3.1 Visualizzazione

3.2 Configurazione

3.3 Stati operativi

4.0 Installazione

4.1 Annessione

4.2 Primo montaggio

5.0 Sostituzione LC**6.0 Eliminazione degli errori**

Errore

Causa

Rimedio

7.0 Smaltimento**8.0 Contrassegno**

Le presenti istruzioni per l'uso servono al funzionamento sicuro del sistema automatico di lubrificazione, concepito per l'impiego su macchine e impianti e utilizzato per la lubrificazione con grasso di cuscinetti volventi, cuscinetti lisci, catene, guide, ingranaggi scoperti, ecc.

Al ricevimento della fornitura, verificare immediatamente che essa corrisponda all'ordine effettuato. Nessuna garanzia è offerta in caso di reclami per vizi o carenze effettuati successivamente.

Per qualsiasi domanda o problema, contattare il nostro servizio di assistenza ai clienti o il rivenditore locale.

**Primo montaggio**

a	Inserire il set batterie nell'azionamento e farlo scattare in posizione.	
b	Test automatico	
c	Il Display segnala "LC". Dopo 60 sec. si spegne la retroilluminazione.	
1	d) Togliere il tappo di chiusura dall'azionamento e smaltirlo.	5
e	Tenere ferma la LC unicamente alla base. Togliere la protezione di sicurezza per il trasporto e il tappo di chiusura e smaltirli. Schiacciare leggermente LC finché il lubrificante è visibile all'uscita.	
f	Centrare la cartuccia LC sull'azionamento allineandola alla linguetta anteriore e farla cliccare in posizione. Il sistema riconoscerà il volume della LC automaticamente.	
g	Collocare il coperchio sulla LC e ruotarlo fino allo scatto.	
2	L'erogazione di lubrificante è temporizzata.	7
Regolare l'unità di tempo		
a	Mantenere il pulsante SET premuto per 1 sec. per la prima regolazione ① e 5 sec. per modificare la regolazione ②.	
3	b) L'indicazione cambiamento m/w appare.	9
c	Regolare l'unità di tempo (m, w) premendo il pulsante SET: 1x = m (mesi) 2x = w (settimane)	
d	Dopo 3 sec. viene applicata la modifica (senza premere il pulsante SET).	
Impostare il periodo di erogazione		
a	La regolazione è possibile non appena le cifre lampeggiano.	
4	b) Impostare il periodo di erogazione premendo il tasto brevemente oppure premendo a lungo (= scorrere).	9
c	Dopo 3 sec. viene applicata la modifica (senza premere il pulsante SET).	
d	Dopo che le impostazioni sono state acquisite, il sistema si spegne.	
5	Per l'accensione mantenere premuto per 1 sec. il pulsante SET.	11
6	Per spegnere mantenere premuto per 1 sec. il pulsante SET.	11
7	In condizione di vuoto eseguire il cambio del LC e inserire il nuovo set batterie.	11
8	Le erogazioni sono segnalate con "ru".	13
9	Premendo il pulsante SET per 10 sec. viene attivata l'erogazione extra "PU". Seguono tre erogazioni di 2,0 cm ³ ciascuna. Premendo il pulsante SET l'erogazione extra viene interrotta.	13
10	Premendo il pulsante SET per 1 sec. appare l'impostazione selezionata. Dopo aver lasciato il pulsante SET, vengono visualizzati in alternanza per 10 sec. "rd" e il numero di giorni da quando l'evento è stato creato.	13
11	Montaggio sul supporto di montaggio	15
12	Smontaggio dal supporto di montaggio premendo ① e ruotando ② contemporaneamente	15

13	Montaggio secondo la dima di foratura	16																												
	Alla prima messa in funzione l'azionamento è riempito con perma Food grade grease H1 SF10. Per cambiare il lubrificante nell'azionamento premere PURGE (PU) finché il lubrificante contenuto nel LC fuoriesce dall'uscita dell'azionamento.																													
14	a) Connettere il sistema di lubrificazione con il punto di lubrificazione preparato.	17																												
b	Per l'accensione mantenere premuto per 1 sec. il pulsante SET.																													
c	In caso di condizioni ambientali difficili applicare il cappuccio di protezione Heavy Duty sul sistema di lubrificazione e avvertirlo.																													
15	Il LED che lampeggia in rosso e l'indicazione "LC" nel display segnalano la prossima sostituzione del LC. Svitare e rimuovere il coperchio.	19																												
16	Rimuovere la LC e smaltirla.	19																												
17	Sbloccare il set batterie.	20																												
18	Rimuovere il set batterie dall'azionamento e smaltirla.	20																												
19	Inserire il nuovo set batterie nell'azionamento.	19																												
20	Far scattare il set batterie in posizione.	19																												
21	Collocare una nuova LC. Avvitare il coperchio e l'azionamento. Il sistema di azionamento è nuovamente pronto per l'uso.	20																												
22	Viene applicata l'ultima impostazione disponibile.	20																												
	<table border="1"> <thead> <tr> <th>Errore</th> <th>Causa</th> <th>Rimedio</th> <th></th> </tr> </thead> <tbody> <tr> <td>a) Nessuna visualizzazione sul display quando il set batterie è inserita</td> <td>Set batterie scarica Azionamento difettoso</td> <td>Inserire un nuovo set batterie Sostituzione dell'azionamento</td> <td></td> </tr> <tr> <td>b) Il LED lampeggia di rosso / Visualizzazione "OL"</td> <td>La contropressione supera i 50 bar per un periodo più lungo</td> <td>Rimuovere le ostruzioni ⇨ contropressione < 50 bar, azionare il pulsante SET</td> <td>21</td> </tr> <tr> <td>c) Il LED lampeggia di rosso / Visualizzazione "Lo"</td> <td>Il set batterie è stato utilizzato più volte</td> <td>Inserire un nuovo set batterie</td> <td></td> </tr> <tr> <td>d) Il LED lampeggia di rosso / Visualizzazione "ut"</td> <td>Al di sotto della temperatura consentita per un periodo più lungo</td> <td>Mantenere la temperatura corretta, premere il pulsante SET</td> <td></td> </tr> <tr> <td>e) Il LED lampeggia di rosso / Visualizzazione "Er"</td> <td>Motore difettoso</td> <td>Sostituzione dell'azionamento</td> <td>22</td> </tr> <tr> <td>f) LC collocata / Visualizzazione "LC"</td> <td>L'azionamento non riconosce la LC</td> <td>Ricollocare la LC oppure premere il pulsante SET per 1 sec. Sostituire la LC</td> <td></td> </tr> </tbody> </table>	Errore	Causa	Rimedio		a) Nessuna visualizzazione sul display quando il set batterie è inserita	Set batterie scarica Azionamento difettoso	Inserire un nuovo set batterie Sostituzione dell'azionamento		b) Il LED lampeggia di rosso / Visualizzazione "OL"	La contropressione supera i 50 bar per un periodo più lungo	Rimuovere le ostruzioni ⇨ contropressione < 50 bar, azionare il pulsante SET	21	c) Il LED lampeggia di rosso / Visualizzazione "Lo"	Il set batterie è stato utilizzato più volte	Inserire un nuovo set batterie		d) Il LED lampeggia di rosso / Visualizzazione "ut"	Al di sotto della temperatura consentita per un periodo più lungo	Mantenere la temperatura corretta, premere il pulsante SET		e) Il LED lampeggia di rosso / Visualizzazione "Er"	Motore difettoso	Sostituzione dell'azionamento	22	f) LC collocata / Visualizzazione "LC"	L'azionamento non riconosce la LC	Ricollocare la LC oppure premere il pulsante SET per 1 sec. Sostituire la LC		
Errore	Causa	Rimedio																												
a) Nessuna visualizzazione sul display quando il set batterie è inserita	Set batterie scarica Azionamento difettoso	Inserire un nuovo set batterie Sostituzione dell'azionamento																												
b) Il LED lampeggia di rosso / Visualizzazione "OL"	La contropressione supera i 50 bar per un periodo più lungo	Rimuovere le ostruzioni ⇨ contropressione < 50 bar, azionare il pulsante SET	21																											
c) Il LED lampeggia di rosso / Visualizzazione "Lo"	Il set batterie è stato utilizzato più volte	Inserire un nuovo set batterie																												
d) Il LED lampeggia di rosso / Visualizzazione "ut"	Al di sotto della temperatura consentita per un periodo più lungo	Mantenere la temperatura corretta, premere il pulsante SET																												
e) Il LED lampeggia di rosso / Visualizzazione "Er"	Motore difettoso	Sostituzione dell'azionamento	22																											
f) LC collocata / Visualizzazione "LC"	L'azionamento non riconosce la LC	Ricollocare la LC oppure premere il pulsante SET per 1 sec. Sostituire la LC																												
24	Azionamento da eseguire alla fine della durata del prodotto riciclato.	23																												

**! = Atenção Perigo**

Para que o sistema de lubrificação não represente qualquer perigo, o operador deve assegurar:

- que apenas pessoal qualificado trabalha no e com o sistema de lubrificação;
- que o pessoal possui à sua disposição e respeita sempre o manual de instruções durante todos os respectivos trabalhos;
- que, durante a montagem ou trabalhos de manutenção, são cumpridos os regulamentos de segurança e protecção de acidentes necessários;
- que o sistema de lubrificação é correctamente utilização e não é ajustado de forma incorrecta.

Ter em atenção as fichas de dados de segurança dos óleos e massas.

Evitar o contacto do óleo / massa com os olhos, pele e vestuário bem como a ingestão de óleo / massa.



Não deixar escorrer óleo / massa para o solo ou para os esgotos.

Óleo / gordura nas vias de transporte resulta num perigo de escorregamento demasiado elevado. Limpar imediatamente o piso com um produto adequado.

Baterias:

Não reutilizar!



Não abrir!



Não colocar no fogo!



Não carregar!

i = Nota, Dica

As fichas de dados do lubrificante podem ser obtidas através da nossa página principal ou no distribuidor local.

Não são assumidas quaisquer responsabilidades por danos e avarias que sejam causados por utilização incorrecta ou trabalhos incorrectos no e com o sistema de lubrificação.

O sistema de lubrificação corresponde, no momento da entrega, ao actual estado da técnica e é considerado de funcionamento seguro.

Devido ao constante desenvolvimento dos produtos, reservamo-nos o direito a efetuar alterações ao produto que não comprometam o respetivo funcionamento, sem necessidade de comunicação prévia.



Proteja o meio ambiente reciclando as matérias-primas valiosas. Respeite as diretivas de reciclagem válidas no seu país.

- A Tampa (reutilizável)
- B LC abastecida
(não pode ser reabastecido)
- C Kit de bateria (não reutilizável)
- D Motor (reutilizável)
- E Condições de armazenamento
- F Temperatura de utilização
- G1 Alcalina
- G2 Lítio
- H Tempo de dispensação
- I Orientação do eixo
- J Emissão de ruído aéreo
- K LED
- L Tampão vazamento
- M Resíduos com lubrificação
- N Data de instalação e substituição
- O Bloqueio de transporte
- P Visor
- Q Botão SET
- R Quantidade dispensada
- S Mantenha o botão SET premido
- T Solte o botão SET
- U Em funcionamento (intermitente)
- V LC vazia
- W Cobertura de proteção Heavy Duty
- X Eliminação da bateria
- Y Matriz de perfuração

1.0 Características**2.0 Peças / primeira montagem****3.0 Utilização**

3.1 Indicação

3.2 Configuração

3.3 Estados operacionais

4.0 Instalação

4.1 Montagem

4.2 Colocação em serviço

5.0 Substituição LC**6.0 Eliminação do erro**

Erro

Causa

Resolução

7.0 Eliminação**8.0 Marcação**

As instruções servem para garantir um trabalho seguro no e com o sistema de lubrificação automática, que se destina ao uso em máquinas e sistemas e que lubrifica com massa os rolamentos deslizantes, as correntes, as guias, as engrenagens abertas, etc.

Imediatamente após a recepção, verifique se a entrega coincide com a sua encomenda. Não é assumida garantia por quaisquer defeitos reclamados posteriormente.

No caso de dúvidas ou problemas, entre em contacto com o nosso serviço ao cliente ou o seu comerciante local.



Montagem inicial	
a	Insira o kit de bateria no motor e encaixe-o.
b	Autoteste automático
c	O visor apresenta "LC". A iluminação de fundo apaga-se após 60 segundos.
1	d Remova o tampão vazamento do motor e descarte-o. 5
e	Segurar a LC unicamente pelo fundo. Remova e descarte o bloqueio de transporte e o tampão vazamento. Pressione a LC levemente até que apareça lubrificante na saída.
f	Coloque a LC no motor de forma centrada, alinhando-a com a aba frontal e encaixe-a. O tamanho da LC é reconhecido automaticamente.
g	Coloque a tampa sobre a LC e gire-a até encaixar no lugar.
2	A distribuição do lubrificante é controlada por tempo. 7
Defina a unidade de tempo	
a	Pressione e segure o botão SET por 1 segundo para a configuração inicial ① e por 5 segundos para alterar a configuração ②.
3	b A indicação de alteração m / w é exibida. 9
c	Defina a unidade de tempo (m, w) pressionando o botão SET: 1x = m (meses) 2x = w (semanas)
d	Após 3 segundos, a alteração é assumida (sem premir o botão SET).
Configure a duração do tempo de dispensação	
a	A configuração é possível assim que os algarismos começarem a piscar.
4	b Defina a duração do tempo de dispensação pressionando o botão uma vez ou continuamente (= incrementar). 9
c	Após 3 segundos, a alteração é assumida (sem premir o botão SET).
d	Após ter aceite as configurações, o sistema desliga-se.
5	Para ligar, mantenha o botão SET premido durante 1 segundo. 11
6	Para desligar, mantenha o botão SET premido durante 1 segundo. 11
7	Quando estiver vazia, efetue a troca da LC e coloque um kit de bateria novo. 11
8	As descargas são indicadas por meio de "ru". 13
9	Premindo o botão SET durante 10 segundos, é ativada a descarga adicional "PU". Seguem-se três descargas com 2,0 cm ³ cada. Premindo o botão SET, a descarga adicional é cancelada. 13
10	Premindo o botão SET durante 1 segundo, é exibida a configuração selecionada. Depois de soltar o botão SET, serão exibidos alternadamente, durante 10 segundos, "rd" e o número de dias desde que a ocorrência existe. 13
11	Montagem no suporte de montagem 15
12	Desmonte o suporte de montagem pressionando ① e girando-o ② ao mesmo tempo 15

13	Montagem segundo a matriz de perfuração 16																											
	O motor encontra-se pré-preenchido com massa lubrificante de grau alimentar perma H1 SF10 aquando da primeira colocação em funcionamento. Para substituir a massa lubrificante do motor, acione a descarga adicional PURGE (PU) até que o lubrificante contido na LC saia pela saída do motor.																											
14	a Conecte o sistema de lubrificação ao ponto de lubrificação preparado. 17																											
b	Para ligar, mantenha o botão SET premido durante 1 segundo.																											
c	Em condições ambientais adversas, coloque a cobertura de proteção Heavy Duty no sistema de lubrificação e aparafuse-a.																											
15	O LED vermelho a piscar e a indicação "LC" no visor sinalizam a necessidade de trocar o LC. Desparafuse e remova a tampa. 19																											
16	Retire e descarte a LC. 19																											
17	Desbloqueie o kit de bateria. 20																											
18	Remova o kit de bateria do motor e descarte-o. 20																											
19	Insira um novo kit de bateria no motor. 19																											
20	Encaixe o kit de bateria no lugar. 19																											
21	Coloque uma nova LC. Enrosque a tampa no motor. O sistema de lubrificação está operacional novamente. 20																											
22	A última configuração disponível é assumida. 20																											
23	<table border="1"> <thead> <tr> <th>Erro</th> <th>Causa</th> <th>Resolução</th> </tr> </thead> <tbody> <tr> <td>a</td> <td>Nenhuma indicação no visor com o kit de bateria inserido</td> <td>Kit de bateria vazio Motor avariado</td> <td>Insira um novo kit de bateria Substitua o motor</td> </tr> <tr> <td>b</td> <td>LED pisca a vermelho / Indicação "OL"</td> <td>Contrapressão excede os 50 bar durante um período de tempo longo</td> <td>Cancele os bloqueios ⇒ Contrapressão < 50 bar, acione o botão SET</td> </tr> <tr> <td>c</td> <td>LED pisca a vermelho / Indicação "Lo"</td> <td>O kit de bateria foi utilizado várias vezes</td> <td>Insira um novo kit de bateria</td> </tr> <tr> <td>d</td> <td>LED pisca a vermelho / Indicação "ut"</td> <td>Temperatura admissível não foi atingida durante um período de tempo longo</td> <td>Mantenha a temperatura admissível, acione o botão SET</td> </tr> <tr> <td>e</td> <td>LED pisca a vermelho / Indicação "Er"</td> <td>Motor de acionamento avariado</td> <td>Substitua o motor</td> </tr> <tr> <td>f</td> <td>LC conectada / Indicação "LC"</td> <td>O motor não reconheceu a LC</td> <td>Coloque a LC novamente ou pressione o botão SET por 1 segundo Substitua a LC</td> </tr> </tbody> </table>	Erro	Causa	Resolução	a	Nenhuma indicação no visor com o kit de bateria inserido	Kit de bateria vazio Motor avariado	Insira um novo kit de bateria Substitua o motor	b	LED pisca a vermelho / Indicação "OL"	Contrapressão excede os 50 bar durante um período de tempo longo	Cancele os bloqueios ⇒ Contrapressão < 50 bar, acione o botão SET	c	LED pisca a vermelho / Indicação "Lo"	O kit de bateria foi utilizado várias vezes	Insira um novo kit de bateria	d	LED pisca a vermelho / Indicação "ut"	Temperatura admissível não foi atingida durante um período de tempo longo	Mantenha a temperatura admissível, acione o botão SET	e	LED pisca a vermelho / Indicação "Er"	Motor de acionamento avariado	Substitua o motor	f	LC conectada / Indicação "LC"	O motor não reconheceu a LC	Coloque a LC novamente ou pressione o botão SET por 1 segundo Substitua a LC
Erro	Causa	Resolução																										
a	Nenhuma indicação no visor com o kit de bateria inserido	Kit de bateria vazio Motor avariado	Insira um novo kit de bateria Substitua o motor																									
b	LED pisca a vermelho / Indicação "OL"	Contrapressão excede os 50 bar durante um período de tempo longo	Cancele os bloqueios ⇒ Contrapressão < 50 bar, acione o botão SET																									
c	LED pisca a vermelho / Indicação "Lo"	O kit de bateria foi utilizado várias vezes	Insira um novo kit de bateria																									
d	LED pisca a vermelho / Indicação "ut"	Temperatura admissível não foi atingida durante um período de tempo longo	Mantenha a temperatura admissível, acione o botão SET																									
e	LED pisca a vermelho / Indicação "Er"	Motor de acionamento avariado	Substitua o motor																									
f	LC conectada / Indicação "LC"	O motor não reconheceu a LC	Coloque a LC novamente ou pressione o botão SET por 1 segundo Substitua a LC																									
24	Quando chegar ao fim de vida, elimine o acionamento através da reciclagem. 23																											



= **Внимание: опасность**

Для того чтобы система смазки не создавала опасности, оператор должен обеспечить соблюдение следующих требований:

- с системой смазки должен работать только квалифицированный персонал;
- при проведении любых работ у персонала всегда должно быть рядом руководство по эксплуатации, которого необходимо придерживаться;
- в процессе монтажа или технического обслуживания должны соблюдаться все необходимые правила и требования техники безопасности;
- система смазки должна использоваться надлежащим образом и по назначению, с правильными настройками и без внесения в нее изменений.

Соблюдать данные в паспортах безопасности на масла и смазки.

Избегать контакта масла / смазки с глазами, кожей и одеждой, а также избегать проглатывания масла / смазки.



Не допускать попадания масла / смазки в грунт или канализацию.

Попадание масла / смазки на транспортные пути создает опасность скольжения. Немедленно помыть пол соответствующими моющими средствами.

Батареи:



Не использовать повторно!



Не открывать!



Не бросать в огонь!



Не заряжать!

= **Указание, совет**

Паспорта безопасности на смазочные материалы можно заказать через нашу домашнюю страницу или у локального дилера.

Мы не берем на себя ответственность за повреждения и эксплуатационные сбои, вызванные ненадлежащим применением и неправильной работой со смазочной системой.

На момент отгрузки система смазки соответствует актуальному уровню техники и является безопасной в эксплуатации.

В связи с постоянным совершенствованием продукции мы оставляем за собой право без предварительного уведомления вносить в изделия изменения, которые не влияют на их функциональные возможности.



В целях охраны окружающей среды передавайте ценное сырье на вторичную переработку. Придерживайтесь положений по утилизации, действующих в Вашей стране.

- Ⓐ Крышка (многораз.)
- Ⓑ LC заполн. (не наполняется повторно)
- Ⓒ Батарейный блок (не используется повторно)
- Ⓓ Привод (многораз.)
- Ⓔ Условия хранения
- Ⓕ Рабочая температура
- Ⓖ1 Щелочные
- Ⓖ2 Литиевые
- Ⓗ Время нанесения
- Ⓘ Положение при монтаже
- Ⓝ Шумовое загрязнение
- Ⓚ Светодиодный индикатор
- Ⓛ Заглушка
- Ⓜ Отходы, содержащие смазку
- Ⓝ Дата установки / замены
- Ⓞ Транспортировочное крепление
- Ⓟ Дисплей
- Ⓠ Кнопка SET
- Ⓡ Количество нанесенной смазки
- Ⓢ Удерживать кнопку SET
- Ⓣ Отпустить кнопку SET
- Ⓤ В рабочем режиме (мигает)
- Ⓥ LC опорожн.
- Ⓦ Защитная крышка Heavy Duty
- Ⓧ Утилизация батареи
- Ⓨ Шаблон для сверления

- 1.0 Характеристики
- 2.0 Детали / первый монтаж
- 3.0 Управление
 - 3.1 Индикация
 - 3.2 Конфигурация
 - 3.3 Рабочие состояния
- 4.0 Установка
 - 4.1 Монтаж
 - 4.2 Ввод в эксплуатацию
- 5.0 Замена LC
- 6.0 Устранение ошибок
 - Ошибка
 - Причина
 - Действия по ее устранению
- 7.0 Утилизация
- 8.0 Маркировка



Инструкция предназначена для обеспечения безопасной работы с автоматической системой смазки, которая используется для нанесения консистентной смазки на подшипники качения и скольжения, цепи, направляющие, открытые приводы и т.п. в машинах и установках.

После получения Вашего заказа сразу проверьте правильность его комплектации. В случае позднего заявления о недостающей комплектации компания не берет на себя гарантийных обязательств.

В случае возникновения вопросов или проблем обращайтесь в нашу клиентскую службу или к местному дилеру.



Первоначальный монтаж		
a	Вставить батарейный блок в привод до щелчка.	
b	Автоматическая самодиагностика	
c	На дисплее появится "LC". Через 60 с фоновая подсветка погаснет.	
d	Удалить заглушку из привода и утилизировать.	5
e	Держать LC только за нижнюю часть. Удалить транспортировочное крепление и заглушку и утилизировать. Слегка нажать на LC, чтобы из выпускного отверстия вышла смазка.	
f	Установить LC по центру привода, повернув его до переднего язычка, и зафиксировать. Размер LC распознается автоматически.	
g	Установить крышку на LC и повернуть до щелчка.	
2	Подача смазки осуществляется по времени.	7
Настроить единицу времени		
a	При начальной настройке ① удерживать кнопку SET 1 с, а при изменении настройки ② - 5 с.	
b	Появится индикатор изменения m / w.	9
c	Настроить единицу времени (m, w) путем нажатия кнопки SET: 1x = m (месяца) 2x = w (недели)	
d	Изменение вступит в силу через 3 с (без нажатия кнопки SET).	
Настроить время нанесения		
a	Настройку можно выполнить, если на экране мигают цифры.	
b	Настроить время нанесения с помощью однократного нажатия или удерживания кнопки (= прокрутка).	9
c	Изменение вступит в силу через 3 с (без нажатия кнопки SET).	
d	После сохранения настроек система отключается.	
5	Для включения нажмите и удерживайте кнопку SET в течение 1 с.	11
6	Для выключения нажмите и удерживайте кнопку SET в течение 1 с.	11
7	Если устройство LC пустое, замените его и вставьте новый батарейный блок.	11
8	Процесс нанесения смазки будет обозначаться буквами "ru".	13
9	Удержание кнопки SET в течение 10 с приводит к активации специальной процедуры нанесения смазки "PU". Выполняются три операции, в рамках каждой из которых наносится по 2,0 см ³ смазки. После нажатия кнопки SET специальная процедура нанесения смазки будет прервана.	13
10	Удержание кнопки SET в течение 1 с приводит к активации выбранной настройки. После отпускания кнопки SET на экране в течение 10 с попеременно отображается "gd" и количество дней с момента возникновения события.	13
11	Монтаж на монтажное крепление	15
12	Демонтаж монтажного крепления осуществляется путем одновременного нажатия ① и поворота ②	15

13	Монтаж по шаблону для сверления	16																											
	При первом вводе в эксплуатацию привод заполнен смазкой perma Food grade grease H1 SF10. Для замены смазки в приводе необходимо активировать специальную процедуру нанесения смазки PURGE (PU), чтобы содержащаяся в LC смазка вышла через выпускное отверстие привода.																												
14	a Присоединить систему смазки к подготовленной точке смазки. b Для включения нажмите и удерживайте кнопку SET в течение 1 с. c При неблагоприятных условиях окружающей среды установить и привинтить к системе смазки защитную крышку Heavy Duty.	17																											
15	Мигающий красный светодиодный индикатор и надпись "LC" на экране сигнализируют о необходимости проведения замены LC. Отвинтить и снять крышку.	19																											
16	Снять LC и утилизировать.	19																											
17	Разблокировать батарейный блок.	20																											
18	Извлечь батарейный блок из привода и утилизировать.	20																											
19	Вставить новый батарейный блок в привод.	19																											
20	Зафиксировать батарейный блок.	19																											
21	Установить новый LC. Привинтить к приводу крышку. После этого система смазки снова будет готова к применению.	20																											
22	Последние настройки будут сохранены в памяти.	20																											
<table border="1"> <thead> <tr> <th>Ошибка</th> <th>Причина</th> <th>Действия по ее устранению</th> </tr> </thead> <tbody> <tr> <td>a</td> <td>Отсутствует индикация на дисплее при установленном батарейном блоке</td> <td>Батарейный блок разряжен Привод неисправен</td> <td>Вставить новый батарейный блок Замените привод</td> </tr> <tr> <td>b</td> <td>Светодиодный индикатор мигает красным цветом / индикация "OL"</td> <td>Показатель противодавления в течение длительного периода времени превышает 50 бар</td> <td>Снимите блокировку ⇒ Если противодавление < 50 бар, нажмите кнопку SET</td> </tr> <tr> <td>c</td> <td>Светодиодный индикатор мигает красным цветом / индикация "Lo"</td> <td>Батарейный блок использовался несколько раз</td> <td>Вставить новый батарейный блок</td> </tr> <tr> <td>d</td> <td>Светодиодный индикатор мигает красным цветом / индикация "ut"</td> <td>В течение длительного периода времени показатель температуры ниже допустимого значения</td> <td>Здобейтесь установления допустимой температуры, используйте кнопку SET</td> </tr> <tr> <td>e</td> <td>Светодиодный индикатор мигает красным цветом / индикация "Er"</td> <td>Двигатель привода неисправен</td> <td>Замените привод</td> </tr> <tr> <td>f</td> <td>LC установлен / индикация "LC"</td> <td>Привод не распознал LC</td> <td>Повторно установить LC или нажать кнопку SET и удерживать ее 1 с Заменить LC</td> </tr> </tbody> </table>			Ошибка	Причина	Действия по ее устранению	a	Отсутствует индикация на дисплее при установленном батарейном блоке	Батарейный блок разряжен Привод неисправен	Вставить новый батарейный блок Замените привод	b	Светодиодный индикатор мигает красным цветом / индикация "OL"	Показатель противодавления в течение длительного периода времени превышает 50 бар	Снимите блокировку ⇒ Если противодавление < 50 бар, нажмите кнопку SET	c	Светодиодный индикатор мигает красным цветом / индикация "Lo"	Батарейный блок использовался несколько раз	Вставить новый батарейный блок	d	Светодиодный индикатор мигает красным цветом / индикация "ut"	В течение длительного периода времени показатель температуры ниже допустимого значения	Здобейтесь установления допустимой температуры, используйте кнопку SET	e	Светодиодный индикатор мигает красным цветом / индикация "Er"	Двигатель привода неисправен	Замените привод	f	LC установлен / индикация "LC"	Привод не распознал LC	Повторно установить LC или нажать кнопку SET и удерживать ее 1 с Заменить LC
Ошибка	Причина	Действия по ее устранению																											
a	Отсутствует индикация на дисплее при установленном батарейном блоке	Батарейный блок разряжен Привод неисправен	Вставить новый батарейный блок Замените привод																										
b	Светодиодный индикатор мигает красным цветом / индикация "OL"	Показатель противодавления в течение длительного периода времени превышает 50 бар	Снимите блокировку ⇒ Если противодавление < 50 бар, нажмите кнопку SET																										
c	Светодиодный индикатор мигает красным цветом / индикация "Lo"	Батарейный блок использовался несколько раз	Вставить новый батарейный блок																										
d	Светодиодный индикатор мигает красным цветом / индикация "ut"	В течение длительного периода времени показатель температуры ниже допустимого значения	Здобейтесь установления допустимой температуры, используйте кнопку SET																										
e	Светодиодный индикатор мигает красным цветом / индикация "Er"	Двигатель привода неисправен	Замените привод																										
f	LC установлен / индикация "LC"	Привод не распознал LC	Повторно установить LC или нажать кнопку SET и удерживать ее 1 с Заменить LC																										
23		21																											
22		22																											
24	После окончания срока службы отправьте привод на вторичную переработку.	23																											





Y Bohrschablone
Drilling template
Plantilla para agujeros

4.0 Installation
Installation
Installation

4.1 Anbau
Mounting
Montaje

16

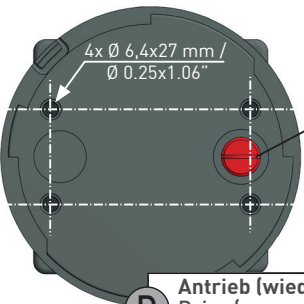

R1/4i
R 1/4 female
R1/4 hembra

D Antrieb (wiederverwendbar)
Drive (re-usable)
Motor (reutilizable)

Y
Bohrschablone
Drilling template
Plantilla para agujeros

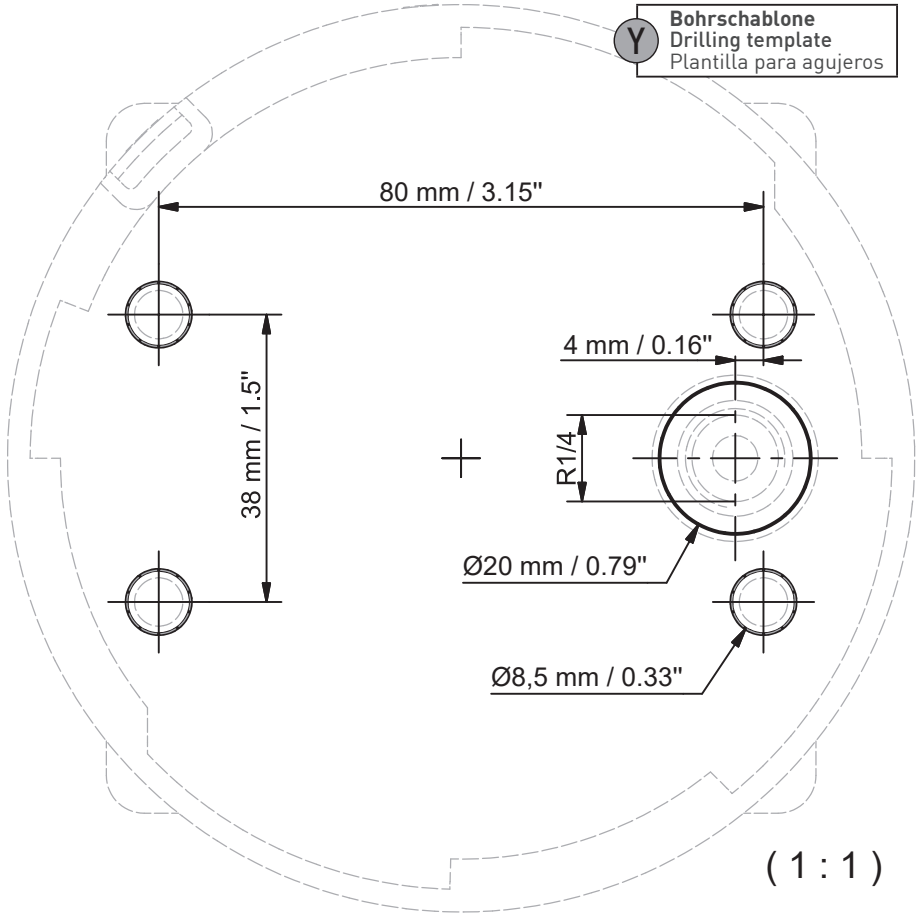

(1 : 1)

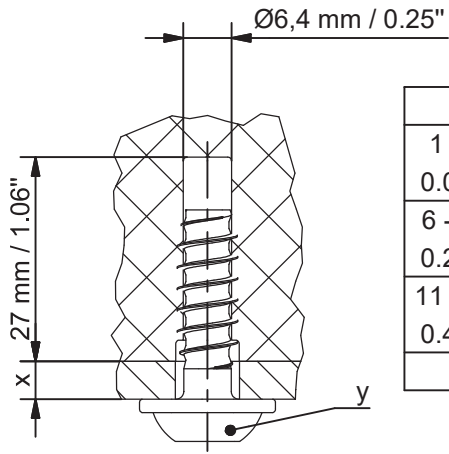
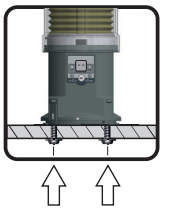

x	y
1 - 5 mm / 0.04 - 0.20"	PT 80 x 20
6 - 10 mm / 0.24 - 0.39"	PT 80 x 25
11 - 15 mm / 0.43 - 0.59"	PT 80 x 30
...	...